

ELSEWEDY
P O L E S

Safety is our Mission
سلامتكم مهمتنا



FIBERGLASS POLES
أعمدة فيبر جلاس

ELSEWEDY
ELECTRIC

Index

Content	Page	الصفحة	المحتوى
Index	1	١	الفهرس
Elsewedy Electric	2	٢	المسوسى إلكترىك
Poles Factory	3	٣	مصنع الأعمدة
Applications	4	٤	الإستخدامات
Advantages	13	١٣	الممىزات
Technical Data	15	١٥	المواصفات الفنية
Designs	26	٢٦	التصمىمات
Gallery	66	٦٦	الصور
Test Certificates	93	٩٣	شهادات الإختبار
Standards	94	٩٤	المعاىىر
Comparison	95	٩٥	المقارنة
ISO Certificates	96	٩٦	شهادات الأىزو
Reference List	97	٩٧	سابقة الأعمال
Local Market	98	٩٨	المسوق الملى
Export Markets	99	٩٩	أسواق التصدىر
Standard Colors	100	١٠٠	درجات الألوان الأساسية

ELSEWEDY ELECTRIC



In a global economy, only the best companies stay alive by adopting several approaches to meet with the important challenges posed by their commerce.

ELSEWEDY ELECTRIC has been able to ensure its survival by implementing a line of business that only meets but surpasses these trials.

ELSEWEDY ELECTRIC is an Egyptian manufacturing company. It was founded in 1938 by the Elsewedy family. The company manufactures and sells integrated energy products and services in seven energy segments.

ELSEWEDY ELECTRIC has become a significant contributor to the economic growth in Egypt through its development into a well-established group with extensive holdings, both locally and beyond borders in several other Middle Eastern & African countries as well as some European & Asian countries. With the goal of providing our customers a one-stop solution in terms of Designing, Engineering, Procurement and Construction.

ELSEWEDY ELECTRIC has more than 13,000 employees working in 30 production facilities located in 14 countries around the world, exporting wide range of high quality and safe products to more than 110 countries worldwide. Its turnover has been rapidly rising during the past few years to reach 2.3 billion USD in 2010, also our production capacity is the first highest one in the region with 250 thousand tons/annum in 2010.

في الاقتصاد العالمي لا يصمد في السوق سوى أفضل الشركات عن طريق اتخاذ العديد من الأساليب لمواجهة التحديات الهامة التي تفرضها أوضاع السوق. وقد كانت السويدية إلكتريك قادرة على ضمان بقائها من خلال تنفيذ خط عمل لم يقتصر فقط على مواجهة هذه التحديات بل وتجاوزها أيضًا.

السويدية إلكتريك هي مجموعة شركات مصرية قامت عائلة السويدية بتأسيسها عام ١٩٣٨. وتعمل في مجال تصنيع وبيع منتجات وحلول الطاقة المتكاملة في سبعة قطاعات تشمل (الكابلات وملحقاتها، الأدوات الكهربائية، الاتصالات، المحولات، توليد طاقة الرياح، التحكم وقياس الطاقة والمشروعات).

وقد أصبحت السويدية إلكتريك مساهمًا هامًا في النمو الاقتصادي في مصر من خلال تطورها ونموها إلى مجموعة عريقة تتمتع بحييزات واسعة على الصعيدين المحلي والدولي في العديد من دول الشرق الأوسط وأفريقيا فضلًا عن بعض الدول الأوروبية والآسيوية، وذلك بهدف توفير الحل الأمثل لعملائها في القطاعات المختلفة.

ويقدر عدد العاملين بالمجموعة بأكثر من ١٣٠٠٠ موظف في ٣٠ مرفقًا إنتاجيًا في ١٤ دولة حول العالم، ينتجون ويصدرون مجموعة واسعة من المنتجات الأمانة عالية الجودة لأكثر من ١١٠ دولة حول العالم، وخلال السنوات القليلة الماضية ارتفعت مبيعاتها سريعًا لتصل إلى ٢,٣ مليار دولار عام ٢٠١٠، كما تعتبر قدرتنا الإنتاجية هي الأولى والأعلى في المنطقة حيث بلغت ٢٥٠ ألف طن في عام ٢٠١٠.



CABLES & ACCESSORIES



ELECTRICAL PRODUCTS



ENERGY MANAGEMENT



TRANSFORMERS



TELECOM



RENEWABLE ENERGY



PROJECTS & DEVELOPMENT





In the context of its mission to supply the market with integrated energy solutions, ELSEWEDY ELECTRIC Group has established its factory of Fiberglass poles in 1998, with production capacity of 30000 pole annually, covering all applications. The factory is equipped by German experience with the latest production technologies and laboratories, where design and testing processes are done according to the most precise International standards.

For being the first factory of its kind in Egypt, its operation scope has extended to include projects in almost all of the Egyptian governorates. Moreover, the factory exported its production to foreign markets such as the Kingdom of Saudi Arabia, Morocco, Yemen and Ghana. In 2015, the factory has been Subjoined to the Egyptian Company for Plastic Industry (ELSEWEDY EGYPLAST), and affiliate of ELSEWEDY ELECTRIC, One of the leading manufacturers of Plastic Compounds and Raw Materials in the Middle East and Africa.

Holding ISO 9001 / ISO 14001 / BS OHSAS 18001, And exporting to more than 35 Arabian, African, European and Asian countries.

في إطار مهمتها لإمداد السوق بحلول الطاقة المتكاملة قامت مجموعة السويدي إلكترىك عام ١٩٩٨م بإنشاء مصنع الأعمدة الفيبر جلاس بطاقة إنتاجية تصل إلى ٣٠٠٠٠ عمود سنويًا تغطي كافة الاستخدامات. تم تجهيز المصنع بأحدث تقنيات الإنتاج والمعامل بخبرة عالمية حيث يتم التصنيع والاختبار وفقًا لأدق المعايير العالمية.

ونظرًا لكونه المصنع الأول من نوعه في مصر امتد نطاق عمله ليشمل مشروعات في معظم محافظات الجمهورية كما تم التصدير لعدد من الأسواق الخارجية مثل المملكة العربية السعودية والمغرب واليمن وغانا. في عام ٢٠١٥ تم ضم مصنع الأعمدة الفيبر جلاس للشركة المصرية لصناعة البلاستيك (السويدي - إيجي بلاست) وهي إحدى شركات السويدي إلكترىك وهي أيضًا من الشركات الرائدة في إنتاج المواد الخام البلاستيكية في الشرق الأوسط وأفريقيا.

والشركة حاصلة على شهادات الجودة
ISO 14001 / ISO 9001 / BS OHSAS 18001
كما تقوم بالتصدير لأكثر من ٣٥ دولة عربية وأفريقية وأوروبية.



- Street lighting Poles
- Decorative Lighting Poles
- Solar Lighting Poles
- Flood Lighting Poles
- Power Transmission Poles
- Traffic Signs Poles
- Signs Carrier Poles
- Flag Poles

- أعمدة إنارة الطرق
- أعمدة إنارة ديكورية
- أعمدة إنارة بالطاقة الشمسية
- أعمدة الأضواء الكاشفة
- أعمدة نقل الطاقة الكهربائية
- أعمدة إشارات المرور
- أعمدة الإعلانات
- أعمدة الأعلام

■ Street lighting Poles

■ أعمدة إنارة الطرق



■ Decorative Lighting Poles

■ أعمدة إنارة ديكورية



■ Solar Lighting Poles

■ أعمدة إنارة بالطاقة الشمسية



■ Flood Lighting Poles

■ أعمدة الأضواء الكاشفة



■ Power Transmission Poles

■ أعمدة نقل الطاقة الكهربائية



■ Traffic Signs Poles

■ أعمدة إشارات المرور



■ Signs Carrier Poles

■ أعمدة الإعلانات



■ Flag Poles

■ أعمدة الأعلام



- عمر افتراضي طويل.
- معزولة كهربائياً.
- خفيفة الوزن.
- سهولة وسرعة المناولة والتركيب.
- تنوع وثبات الألوان حيث لا تحتاج لإعادة الطلاء.
- سطح أملس لا تلتصق به الأبخرة والأتربة.
- مقاومة للأشعة فوق بنفسجية.
- مقاومة عالية للثني والإنحناء.
- مقاومة للاهتزازات مما يتيح عمر أطول للمصابيح.
- مقاومة عالية للرياح تصل إلى ١٦٠ كم / ساعة.
- موفرة إقتصاديّاً.
- تحقق مستوى أمان عالي للإنسان و البيئة.
- تصميمات جذابة مع إمكانية الطباعة على الأعمدة.
- مقاومة للكيمائيات والرطوبة والأملاح حيث تلائم الظروف الجوية في المناطق الساحلية.

- Long Lifespan.
- Electrically Isolated (Non – Conductive).
- Light Weight.
- Ease and Speed of Handling and Installation.
- Diversity and Stability of Colors, Where no need for repainting.
- Smooth Surface non-stick to Dust and Fumes.
- Resistant to Ultra – Violet Rays.
- High Resistant to Bending and Deflection.
- Resistant to Vibrations allowing longer lifespan to Lamps.
- High Resistance to Winds up to 160 KM/H.
- Economically Efficient.
- High Safety Level to Human and Environment.
- Attractive Designs with the ability to print on Poles.
- Resistant to Chemicals, Moisture and Salts, Which suit Weather Conditions in Coastal Areas.

Fiber Poles are manufactured of Plastic reinforced with fiberglass So, they have special features as follows:

- **Have High Mechanical and Dynamic Specifications:** EISewedy Fiberglass Poles are characterized by high mechanical and dynamic properties as they bear wind speed up to 160km/h. they are also resistant to bending and deflection for both fixed load that result from arms and luminaries weight and variable load that result from wind speed.
- **Light Weight:** Comparing to Poles manufactured of other materials like Steel, Wood and Aluminum). The Fiberglass Pole has lighter weight as its specific gravity is 1.65kg/m3.
- **Easy Installation:** Due to Pole light weight, there is no need to use special equipment for installation. As it could be installed by individuals, therefore, its installation by direct burial or Anchor Base is much easier than Poles that manufactured of other materials.
- **Fixed and Multiple colors:** EISewedy Fiberglass poles are available in various colors and according to clients request, Ensuring color stability and resistance to ultraviolet Rays.
- **Resistant to chemicals and corrosion:** EISewedy Fiberglass poles have perfect resistance to Chemicals and bacteria. So, they are suitable for sewage stations.
- **Resistant to Vibrations:** EISewedy Fiberglass poles are manufactured of high flexible materials, So, their vibration rate reach almost half of vibration rate of Poles manufactured of other materials. That provides longer lifespan for lamps.
- **Maintenance:** EISewedy Fiberglass poles don't require repainting due to their colors stability and resistance to weather conditions.
- **Safe:** Fiberglass Poles are manufactured of nonconductive materials so, they are Electrically isolated, which keep peopole life safe away from electric shocks, as well as safety in case of accidents that they get broken when collision with cars and without significant impacts on cars and individuals. On contrary of poles manufactured of other materials, In addition, Fiberglass Poles don't contain environmentally harmful materials that are non-biodegradable in soil.
- **Economically Efficient:** EISewedy Fiberglass Poles don't require special equipment for installation or regular maintenance like poles manufactured of other materials. Also they don't require electrical ground connection, which save cost in these phases.
- **Multiuse Designs:** EISewedy Fiberglass Poles are characterized by various and attractive designs which are suitable for different applications and tastes as well as possibility of designing and printing according to clients requirements.

أعمدة الفيبر جلاس يتم تصنيعها من لدائن مقواة بالفيبر جلاس لذا فإن لها مميزات خاصة كالتالي :

- **ذات مواصفات ميكانيكية وديناميكية عالية :** إن أعمدة السويد الفيبر جلاس تتميز بخواص ميكانيكية وديناميكية عالية وتتحمل سرعة رياح حتى 160 كم/ساعة ، كما أنها مقاومة للثني والانحناء لكل من الحمل الثابت الناتج عن وزن الذراع والكشاف والحمل المتغير الناتج عن سرعة الرياح.
- **خفيفة الوزن :** وذلك بمقارنتها بالأعمدة المصنعة من خامات أخرى (الحديد - الخشب - الألمونيوم) حيث أن الكثافة النوعية لها هي 1.65 كجم/م³.
- **سهولة التركيب :** نظراً لخفة وزنها فإنها لا تحتاج إلى معدات خاصة بالتركيب ويمكن تركيبها بواسطة الأفراد وذلك فإن تركيبها سواء بالفرس أو بقاعدة حديد يعتبر أسهل بكثير من الأعمدة المصنعة من خامات أخرى.
- **ألوان ثابتة ومتعددة :** إن أعمدة السويد الفيبر جلاس متوفرة بألوان متعددة وحسب طلب العميل مع ضمان ثبات اللون ومقاومتها للأشعة فوق البنفسجية.
- **مقاومة للكيميائيات والتآكل :** إن أعمدة السويد الفيبر جلاس مقاومة للكيميائيات تماماً لذا فهي صالحة للاستخدام في محطات الصرف الصحي كما أنها مقاومة للبكتريا المتواجدة في طبقات الأرض.
- **مقاومة للاهتزازات :** حيث أن أعمدة السويد الفيبر جلاس تصنع من خامات ذات مرونة عالية فإن معدل الاهتزاز يبلغ نصف معدل اهتزاز الأعمدة المصنعة من خامات أخرى تقريباً وذلك يؤدي إلى زيادة عمر الثمبات المستخدمة في الإضاءة.
- **الصيانة :** إن أعمدة السويد الفيبر جلاس لا تحتاج إلى إعادة الدهان وذلك لثبات ألوانها وعدم تأثرها بالعوامل الجوية بدرجة كبيرة جداً.
- **الأمــــن :** نظراً لأن الأعمدة الفيبر جلاس يتم تصنيعها من مواد عازلة كهربياً فهي لا توصل التيار الكهربى مما يحافظ على حياة الأشخاص من الصعق الكهربى كما أنها آمنة في حالة الحوادث حيث أنها تنكسر عند اصطدام السيارات بها بسرعة كبيرة ودون تأثير ينكر على السيارات والأفراد على العكس من الأعمدة المصنعة من خامات أخرى ، إضافة إلى ذلك أنها لا تحتوي على مواد ضارة بالبيئة كما أنها غير قابلة للتحلل بالتأثر بعوامل التربة.
- **اقتصاديه :** إن أعمدة السويد الفيبر جلاس لا تحتاج إلى معدات خاصة في التركيب ولا تحتاج إلى صيانة دورية مثل الأعمدة الأخرى بالإضافة إلى أنها لا تحتاج إلى توصيل أرضى وتوفر تكاليف هذه المراحل.
- **تصميمات متعددة الاستخدام :** تتميز أعمدة السويد الفيبر جلاس بتصميمات جذابة ومتنوعة تتلائم مع الاستخدامات والأنواع المختلفة إضافة إلى إمكانية التصميم والطباعة وفقاً لمتطلبات العملاء.

■ Dimensions

■ الأبعاد

Type : Direct Burial

النوع : تثبيت بالغرس

(A) Poles Top 76 mm

(أ) أعمدة بقمة ٧٦ مم

Slop 18 mm/m

all dimensions (mm)

L	H	E	D1	D2	D3	R	S	T	N	M
2000	1500	500	76	112	103	250	250	40	400	180
2500	2000	500	76	121	112	250	250	40	400	180
3000	2500	500	76	130	121	250	250	40	400	180
3500	3000	500	76	139	130	250	250	40	400	180
4000	3500	500	76	148	139	250	250	40	400	180
4500	4000	500	76	157	148	250	250	40	600	210
5000	4500	500	76	166	157	250	250	40	600	210
5500	5000	500	76	175	166	250	250	40	600	300
6000	5500	500	76	184	175	250	250	40	600	300
6500	6000	500	76	193	184	250	250	40	900	300
7000	6500	500	76	202	193	250	250	60	900	300
7500	7000	500	76	211	202	250	250	60	900	300
8000	7000	1000	76	220	202	500	500	60	900	300
8500	7500	1000	76	229	211	500	500	60	900	300
9000	8000	1000	76	238	220	500	500	60	1200	300
9500	8500	1000	76	247	229	500	500	60	1200	300
10000	9000	1000	76	256	238	500	500	60	1200	300
10500	9500	1000	76	265	247	500	500	60	1200	300
11000	10000	1000	76	274	256	500	500	60	1500	300
11500	10500	1000	76	283	265	500	500	60	1500	300
12000	11000	1000	76	292	274	500	500	60	1500	300
12500	11500	1000	76	301	283	500	500	60	1500	300
13000	11500	1500	76	310	283	750	750	60	1500	300
13500	12000	1500	76	319	292	750	750	60	1500	300
14000	12500	1500	76	328	301	750	750	60	1500	300

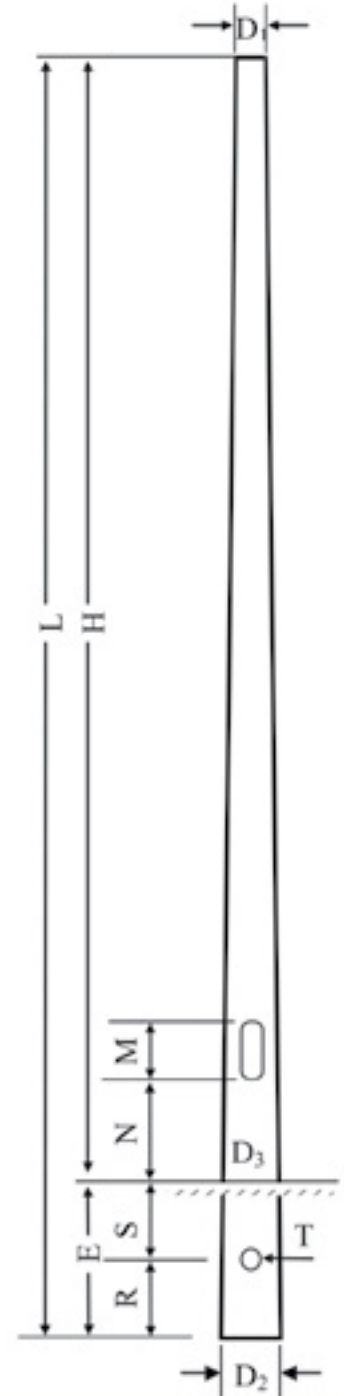

الجدول أعلاه يوضح مقاسات الأعمدة في الاستخدام التمطي (أعمدة إنارة الشوارع) وفيما عدا ذلك يتم إعداد التصميمات حسب متطلبات العميل واستخدامات الأعمدة.

Above table showing poles size in typical used for street lighting poles, so we can make designs according to customer requirements & poles applications.

■ Dimensions

■ الأبعاد

Type : Direct Burial

النوع : تثبيت بالغرس

(B) Poles Top 73 mm

(ب) أعمدة بقمة ٧٣ مم

Slop 13 mm/m

all dimensions (mm)

L	H	E	D1	D2	D3	R	S	T	N	M
2000	1500	500	73	99	92.5	250	250	40	400	180
2500	2000	500	73	105.5	99	250	250	40	400	180
3000	2500	500	73	112	105.5	250	250	40	400	180
3500	3000	500	73	118.5	112	250	250	40	400	180
4000	3500	500	73	125	118.5	250	250	40	400	180
4500	4000	500	73	131.5	125	250	250	40	600	210
5000	4500	500	73	138	131.5	250	250	40	600	210
5500	5000	500	73	144.5	138	250	250	40	600	300
6000	5500	500	73	151	144.5	250	250	40	600	300
6500	6000	500	73	157.5	151	250	250	40	900	300
7000	6500	500	73	164	157.5	250	250	60	900	300
7500	7000	500	73	170.5	164	250	250	60	900	300
8000	7000	1000	73	177	164	500	500	60	900	300
8500	7500	1000	73	183.5	170.5	500	500	60	900	300
9000	8000	1000	73	190	177	500	500	60	1200	300
9500	8500	1000	73	196.5	183.5	500	500	60	1200	300
10000	9000	1000	73	203	190	500	500	60	1200	300
10500	9500	1000	73	209.5	196.5	500	500	60	1200	300
11000	10000	1000	73	216	203	500	500	60	1500	300
11500	10500	1000	73	222.5	209.5	500	500	60	1500	300
12000	11000	1000	73	229	216	500	500	60	1500	300

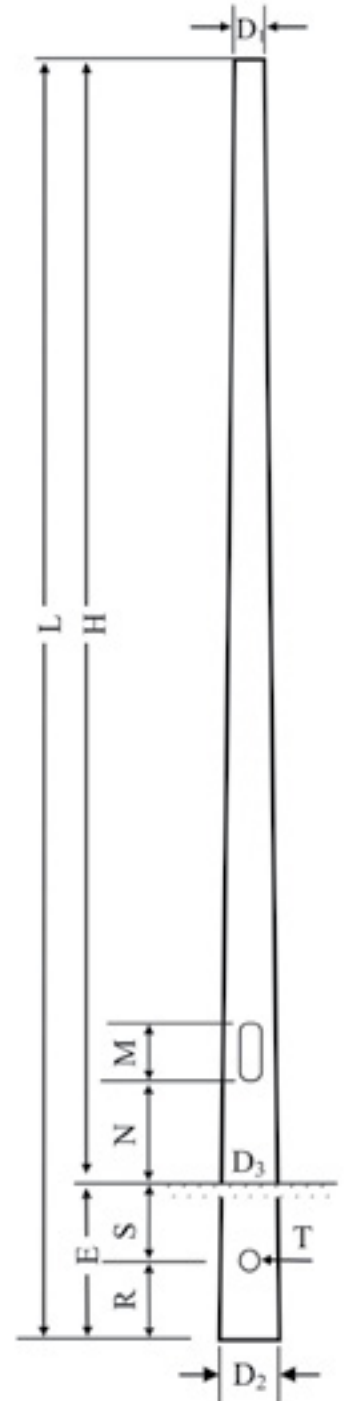

الجدول أعلاه يوضح مقاسات الأعمدة في الاستخدام التمهيدي (أعمدة إنارة الشوارع) وفيما عدا ذلك يتم إعداد التصميمات حسب متطلبات العميل واستخدامات الأعمدة.

Above table showing poles size in typical used for street lighting poles, so we can make designs according to customer requirements & poles applications.

■ Dimensions

■ الأبعاد

Type : Direct Burial

النوع : تثبيت بالغرس

(C) Poles Top 60 mm

(ج) أعمدة بقمة ٦٠ مم

Slop 13 mm/m

all dimensions (mm)

L	H	E	D1	D2	D3	R	S	T	N	M
2000	1500	500	60	86	79.5	250	250	40	400	180
2500	2000	500	60	92.5	86	250	250	40	400	180
3000	2500	500	60	99	92.5	250	250	40	400	180
3500	3000	500	60	105.5	99	250	250	40	400	180
4000	3500	500	60	112	105.5	250	250	40	400	180
4500	4000	500	60	118.5	112	250	250	40	600	210
5000	4500	500	60	125	118.5	250	250	40	600	210
5500	5000	500	60	131.5	125	250	250	40	600	300
6000	5500	500	60	138	131.5	250	250	40	600	300
6500	6000	500	60	144.5	138	250	250	40	900	300
7000	6500	500	60	151	144.5	250	250	60	900	300
7500	7000	500	60	157.5	151	250	250	60	900	300
8000	7000	1000	60	164	151	500	500	60	900	300
8500	7500	1000	60	170.5	157.5	500	500	60	900	300
9000	8000	1000	60	177	164	500	500	60	1200	300
9500	8500	1000	60	183.5	170.5	500	500	60	1200	300
10000	9000	1000	60	190	177	500	500	60	1200	300
10500	9500	1000	60	196.5	183.5	500	500	60	1200	300
11000	10000	1000	60	203	190	500	500	60	1500	300

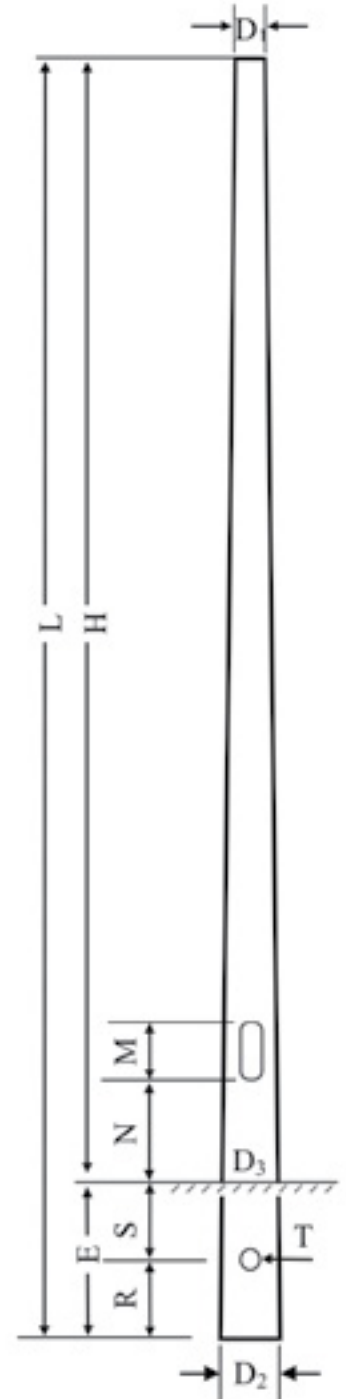

الجدول أعلاه يوضح مقاسات الأعمدة في الاستخدام النمطي (أعمدة إنارة الشوارع) وفيما عدا ذلك يتم إعداد التصاميم حسب متطلبات العميل واستخدامات الأعمدة.

Above table showing poles size in typical used for street lighting poles, so we can make designs according to customer requirements & poles applications.

■ Fixing of Direct Burial Poles

■ طريقة تركيب الأعمدة بالغرس

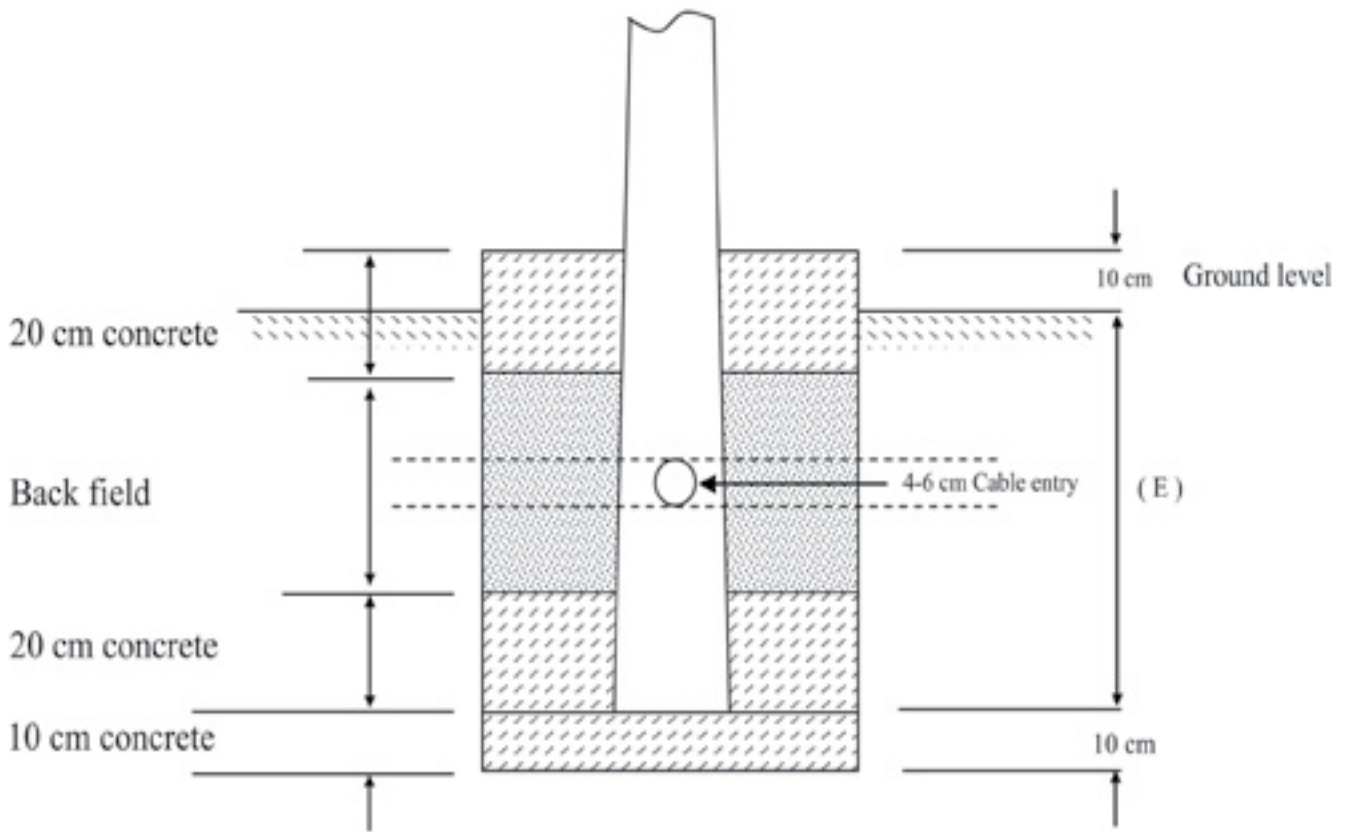

■ Dimensions

■ الأبعاد

Type : Anchor Base.

النوع : تثبيت بالقاعدة

(A) Poles Top 76 mm

(أ) أعمدة بقمة ٧٦ مم

Slop 18 mm/m

all dimensions (mm)

L	D1	D2	N	M
1500	76	103	400	180
2000	76	112	400	180
2500	76	121	400	180
3000	76	130	400	180
3500	76	139	400	180
4000	76	148	600	210
4500	76	157	600	210
5000	76	166	600	300
5500	76	175	600	300
6000	76	184	900	300
6500	76	193	900	300
7000	76	202	900	300
7500	76	211	900	300
8000	76	220	1200	300
8500	76	229	1200	300
9000	76	238	1200	300
9500	76	247	1200	300
10000	76	256	1500	300
10500	76	265	1500	300
11000	76	274	1500	300
11500	76	283	1500	300
12000	76	292	1500	300
12500	76	301	1500	300
13000	76	310	1500	300
13500	76	319	1500	300
14000	76	328	1500	300

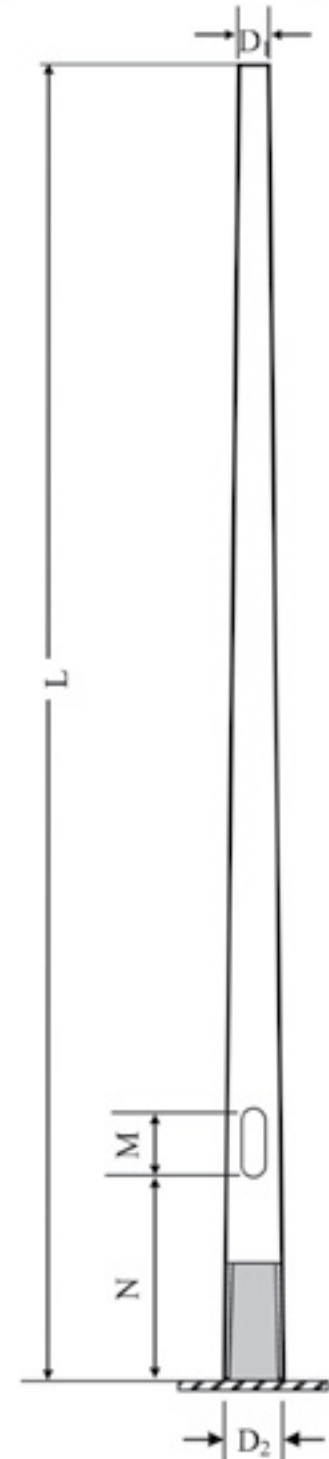

الجدول أعلاه يوضح مقاسات الأعمدة في الاستخدام النمطي (أعمدة إنارة الشوارع) وفيما عدا ذلك يتم إعداد التصميمات حسب متطلبات العميل واستخدامات الأعمدة.

Above table showing poles size in typical used for street lighting poles, so we can make designs according to customer requirements & poles applications.

■ Dimensions

■ الأبعاد

Dimensions of Galvanized Steel Base

أبعاد القواعد الحديدية المجلفنة

(A) Poles Top (76 mm).

(أ) أعمدة بقمة ٧٦ مم

All dimensions (mm)

L	X	X ¹	Y	Y ¹	T	E	∅	A	D	B	C
1500	200	200	150	150	10	250	22	18	100	250	50
2000	200	200	150	150	10	250	22	18	100	250	50
2500	200	200	150	150	10	250	22	18	100	250	50
3000	250	250	200	200	10	250	22	18	100	250	50
3500	250	250	200	200	10	250	22	18	100	250	50
4000	250	250	200	200	10	250	24	20	100	250	50
4500	250	250	200	200	10	250	24	20	100	250	50
5000	350	350	300	300	10	550	24	20	100	300	100
5500	350	350	300	300	10	550	24	20	100	300	100
6000	350	350	300	300	10	550	24	20	100	300	100
6500	350	350	300	300	10	550	24	20	100	300	100
7000	400	400	300	300	10	550	24	20	100	300	100
7500	400	400	300	300	10	550	24	20	100	300	100
8000	400	400	300	300	10	550	26	22	100	300	100
8500	400	400	300	300	10	550	26	22	100	300	100
9000	400	400	300	300	10	550	26	22	100	300	100
9500	400	400	300	300	10	550	26	22	100	300	100
10000	400	400	300	300	10	550	26	22	100	400	100
10500	400	400	300	300	10	550	26	22	100	400	100
11000	400	400	300	300	10	550	26	22	100	400	100
11500	400	400	300	300	10	550	26	22	100	400	100
12000	400	400	300	300	10	550	28	24	100	500	100
12500	450	450	350	350	10	550	28	24	100	500	100
13000	450	450	350	350	10	550	28	24	100	500	100
13500	450	450	350	350	10	550	28	24	100	500	100
14000	450	450	350	350	10	550	28	24	100	500	100

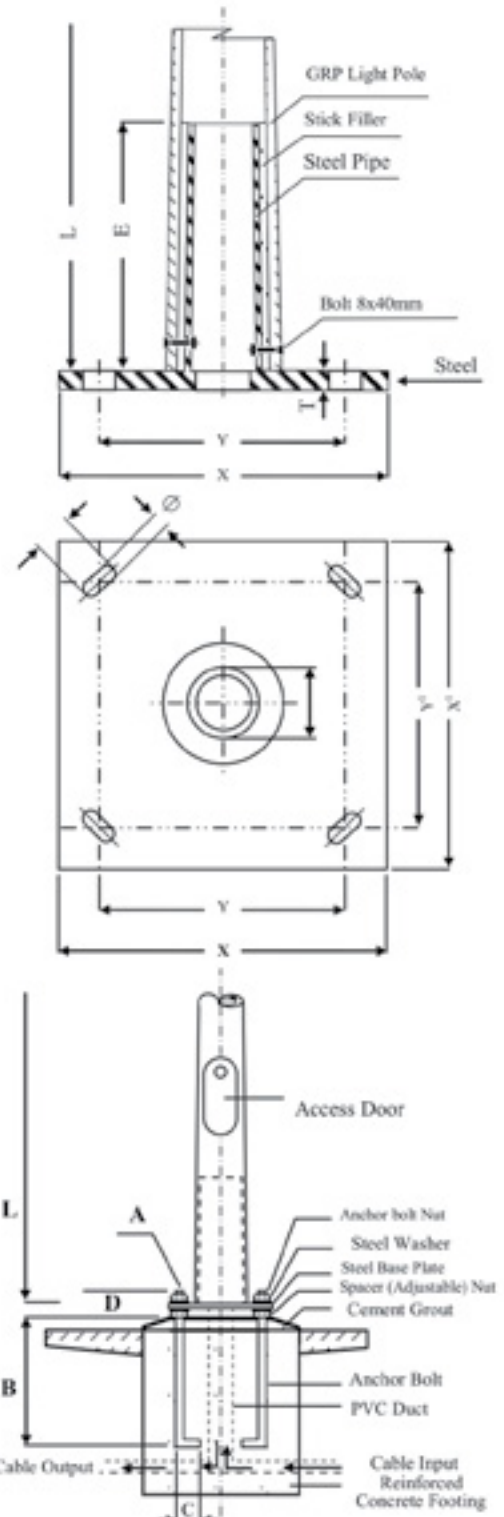

■ Dimensions

■ الأبعاد

Type : Anchor Base.

النوع : تثبيت بالقاعدة

(B) Poles Top 73 mm

(ب) أعمدة بقمة ٧٣ مم

Slop 13 mm/m

all dimensions (mm)

L	D1	D2	N	M
1500	73	92.5	400	80
2000	73	99	400	180
2500	73	105.5	400	180
3000	73	112	400	180
3500	73	118.5	400	180
4000	73	125	600	210
4500	73	131.5	600	210
5000	73	138	600	300
5500	73	144.5	600	300
6000	73	151	900	300
6500	73	157.5	900	300
7000	73	164	900	300
7500	73	170.5	900	300
8000	73	177	1200	300
8500	73	183.5	1200	300
9000	73	190	1200	300
9500	73	196.5	1200	300
10000	73	203	1500	300
10500	73	209.5	1500	300
11000	73	216	1500	300
11500	73	222.5	1500	300
12000	73	229	1500	300

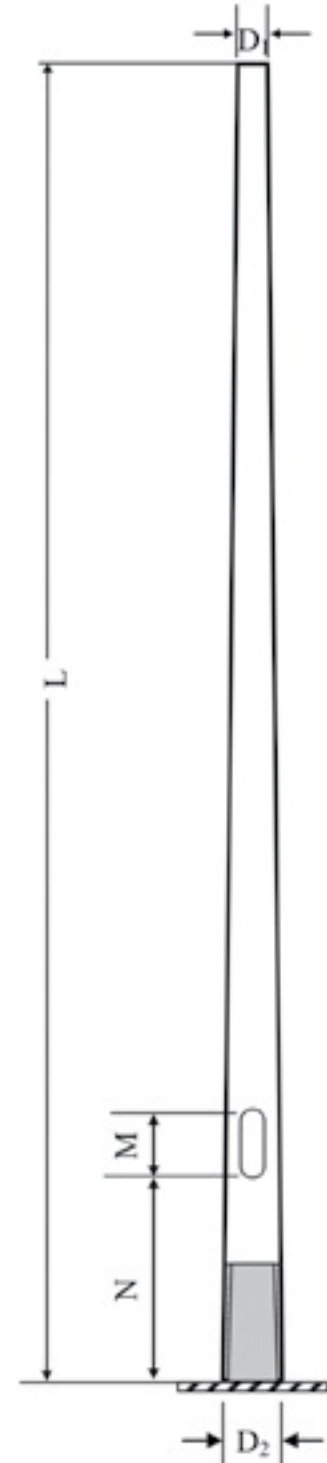

الجدول أعلاه يوضح مقاسات الأعمدة في الاستخدام النمطي (أعمدة إنارة الشوارع) وفيما عدا ذلك يتم إعداد التصميمات حسب متطلبات العميل واستخدامات الأعمدة.

Above table showing poles size in typical used for street lighting poles, so we can make designs according to customer requirements & poles applications.

■ Dimensions

■ الأبعاد

Dimensions of Galvanized Steel Base

أبعاد القواعد الحديدية المجلفنة

(B) Poles Top (73 mm).

(ب) أعمدة بقمة ٧٣ مم

All dimensions (mm)

L	X	X ¹	Y	Y ¹	T	E	∅	A	D	B	C
1500	200	200	150	150	10	250	22	18	100	250	50
2000	200	200	150	150	10	250	22	18	100	250	50
2500	200	200	150	150	10	250	22	18	100	250	50
3000	250	250	200	200	10	250	22	18	100	250	50
3500	250	250	200	200	10	250	22	18	100	250	50
4000	250	250	200	200	10	250	24	20	100	250	50
4500	250	250	200	200	10	250	24	20	100	250	50
5000	300	300	250	250	10	550	24	20	100	300	100
5500	300	300	250	250	10	550	24	20	100	300	100
6000	300	300	250	250	10	550	24	20	100	300	100
6500	300	300	250	250	10	550	24	20	100	300	100
7000	300	300	250	250	10	550	24	20	100	300	100
7500	300	300	250	250	10	550	24	20	100	300	100
8000	350	350	250	250	10	550	26	22	100	300	100
8500	350	350	250	250	10	550	26	22	100	300	100
9000	350	350	250	250	10	550	26	22	100	300	100
9500	350	350	250	250	10	550	26	22	100	300	100
10000	350	350	250	250	10	550	26	22	100	400	100
10500	400	400	300	300	10	550	26	22	100	400	100
11000	400	400	300	300	10	550	26	22	100	400	100
11500	400	400	300	300	10	550	26	22	100	400	100
12000	400	400	300	300	10	550	28	24	100	500	100

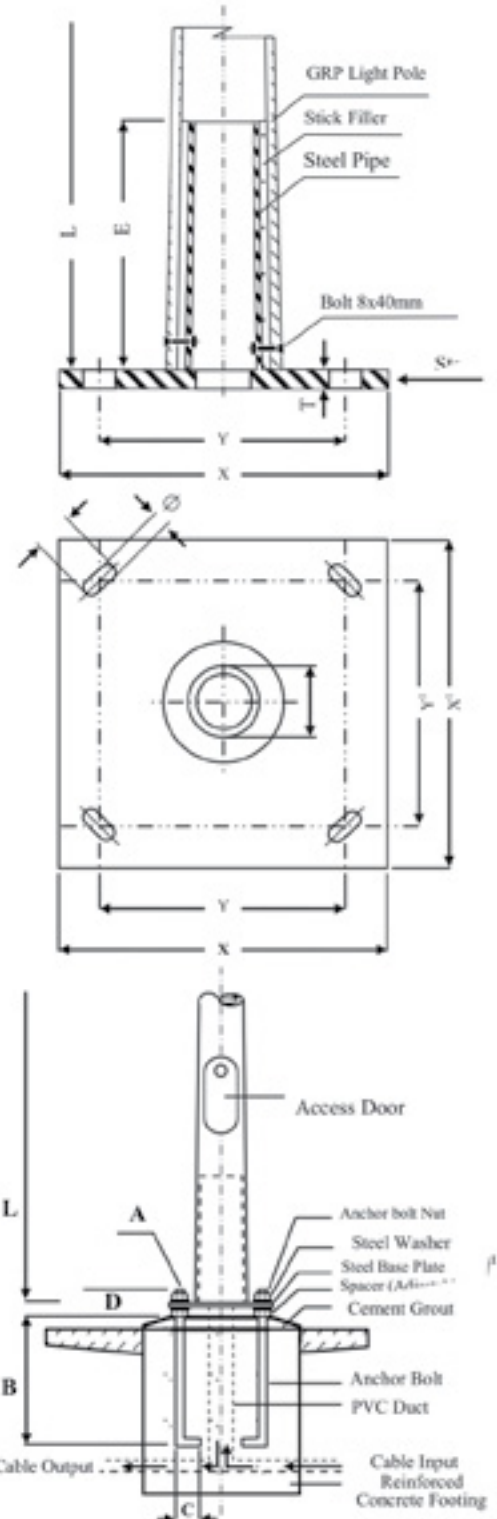

■ Dimensions

■ الأبعاد

Type : Anchor Base.

النوع : تثبيت بالقاعدة

(C) Poles Top 60 mm

(ج) أعمدة بقمة 60 مم

Slop 13 mm/m

all dimensions (mm)

L	D1	D2	N	M
1500	60	79.5	400	180
2000	60	86	400	180
2500	60	92.5	400	180
3000	60	99	400	180
3500	60	105.5	400	180
4000	60	112	600	210
4500	60	118.5	600	210
5000	60	125	600	300
5500	60	131.5	600	300
6000	60	138	900	300
6500	60	144.5	900	300
7000	60	151	900	300
7500	60	157.5	900	300
8000	60	164	1200	300
8500	60	170.5	1200	300
9000	60	177	1200	300
9500	60	183.5	1200	300
10000	60	190	1500	300

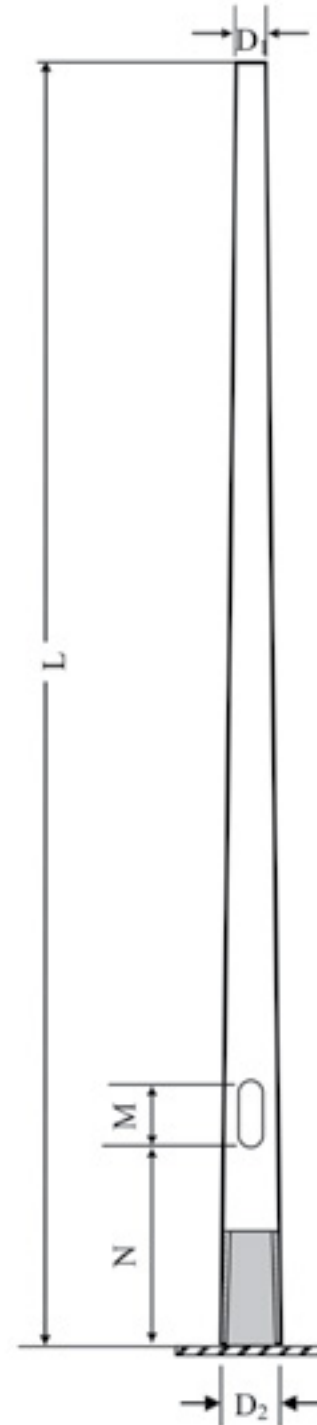

الجدول أعلاه يوضح مقاسات الأعمدة في الاستخدام النمطي (أعمدة إنارة الشوارع) وفيما عدا ذلك يتم إعداد التصميمات حسب متطلبات العميل واستخدامات الأعمدة.

Above table showing poles size in typical used for street lighting poles, so we can make designs according to customer requirements & poles applications.

■ Dimensions

■ الأبعاد

Dimensions of Galvanized Steel Base

أبعاد القواعد الحديدية المجلفنة

(C) Poles Top (60 mm).

All dimensions (mm)

L	X	X ¹	Y	Y ¹	T	E	∅	A	D	B	C
1500	200	200	150	150	10	250	22	18	100	250	50
2000	200	200	150	150	10	250	22	18	100	250	50
2500	200	200	150	150	10	250	22	18	100	250	50
3000	250	250	200	200	10	250	22	18	100	250	50
3500	250	250	200	200	10	250	22	18	100	250	50
4000	250	250	200	200	10	250	24	20	100	250	50
4500	250	250	200	200	10	250	24	20	100	250	50
5000	300	300	250	250	10	550	24	20	100	300	100
5500	300	300	250	250	10	550	24	20	100	300	100
6000	300	300	250	250	10	550	24	20	100	300	100
6500	300	300	250	250	10	550	24	20	100	300	100
7000	300	300	250	250	10	550	24	20	100	300	100
7500	300	300	250	250	10	550	24	20	100	300	100
8000	350	350	250	250	10	550	26	22	100	300	100
8500	350	350	250	250	10	550	26	22	100	300	100
9000	350	350	250	250	10	550	26	22	100	300	100
9500	350	350	250	250	10	550	26	22	100	300	100
10000	350	350	250	250	10	550	26	22	100	400	100

(ج) أعمدة بقمة 60 مم

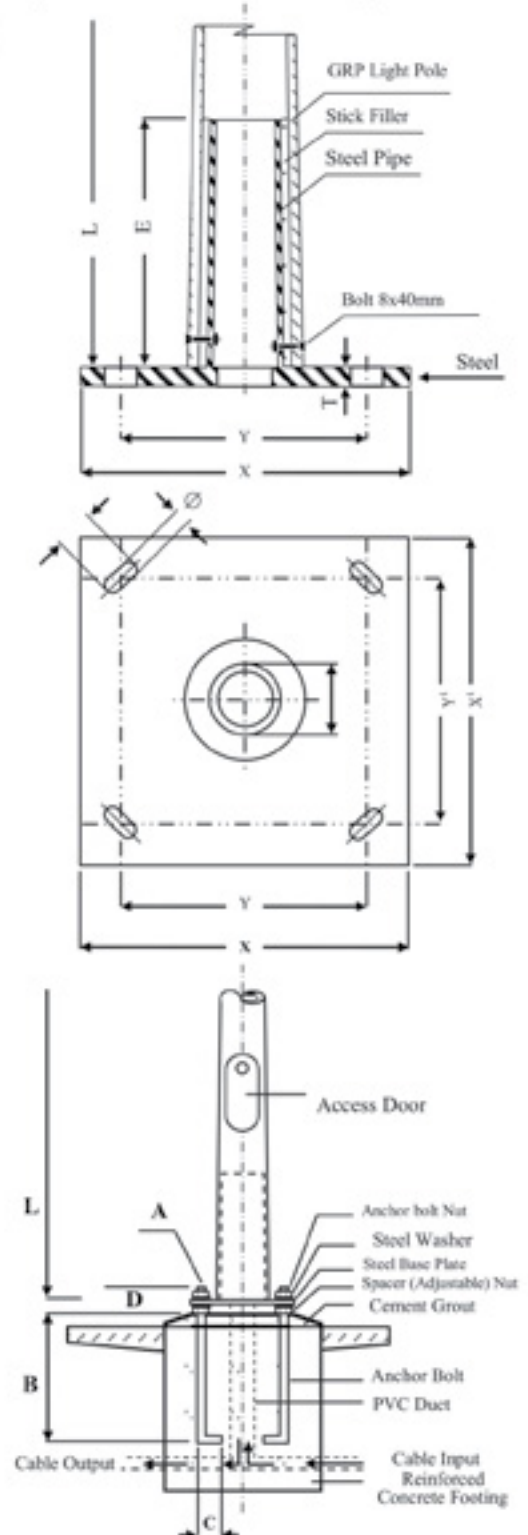

■ Locking Options

■ خيارات الغلق

(1) TERMINAL BLOCK & CIRCUIT BREAKER

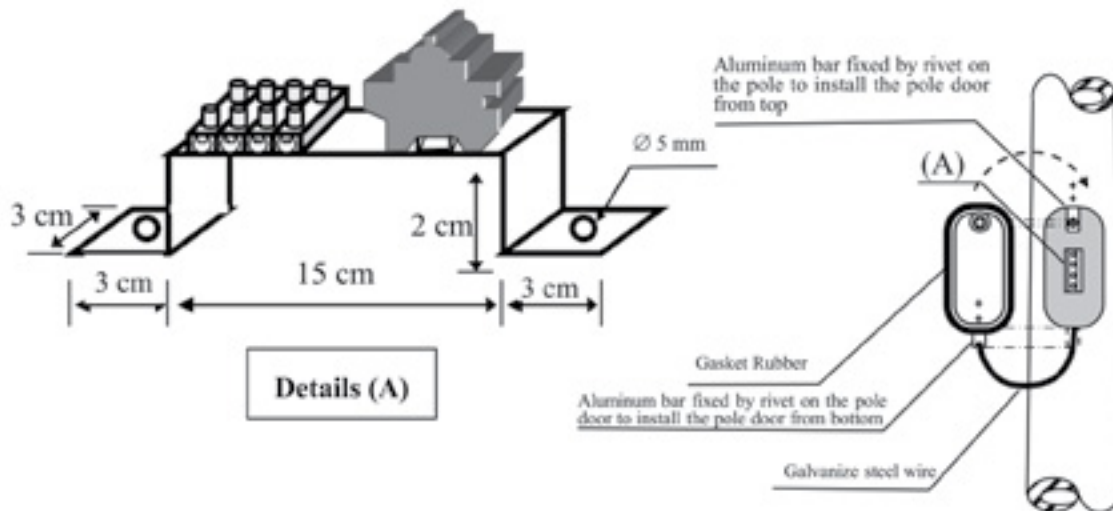

(2) CHANNEL FIXED FUSE BOX

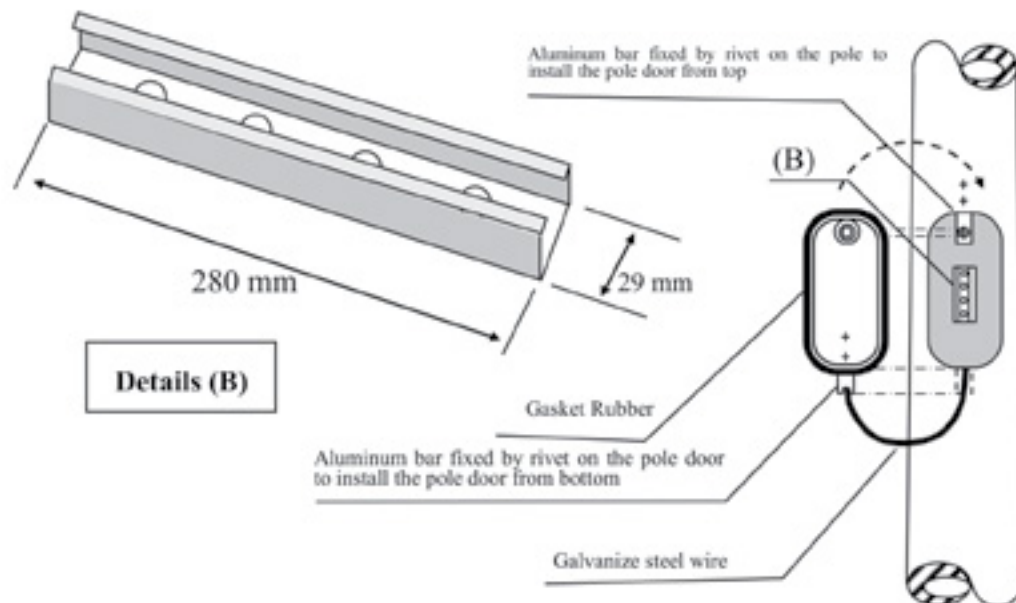

■ Street Lighting Poles

■ أعمدة إنارة الطرق

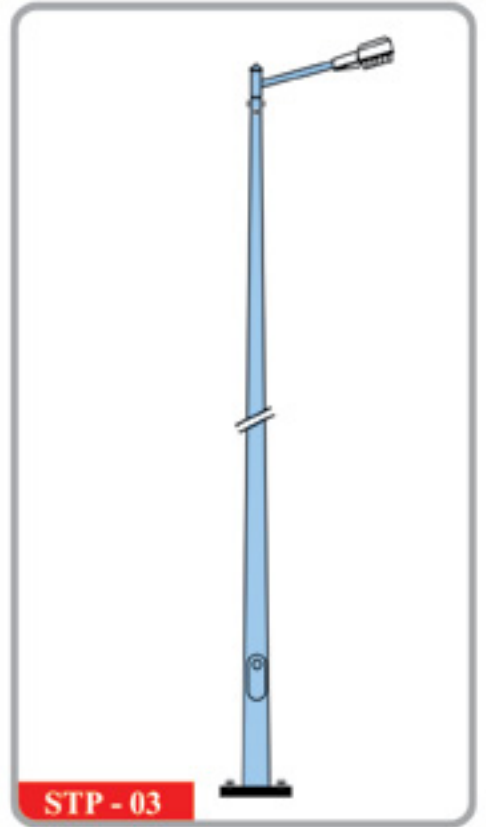
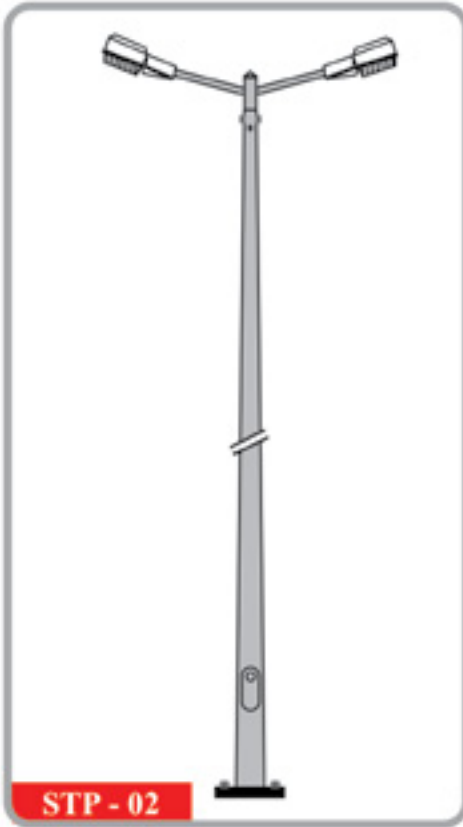
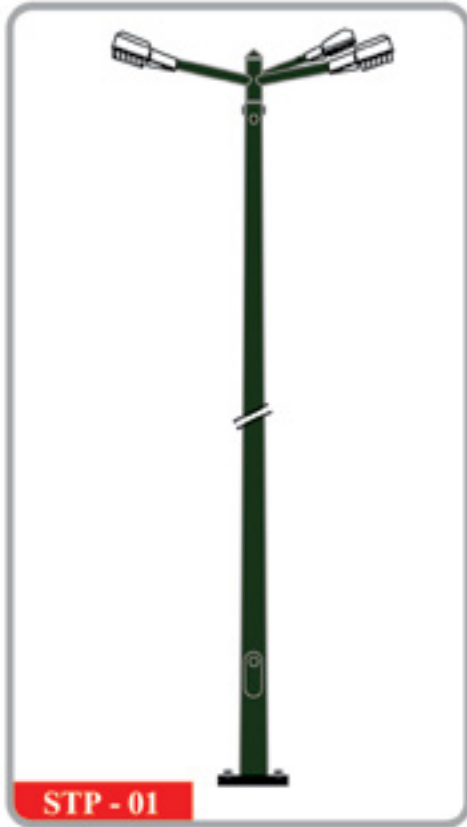

■ Street Lighting Poles

■ أعمدة إنارة الطرق

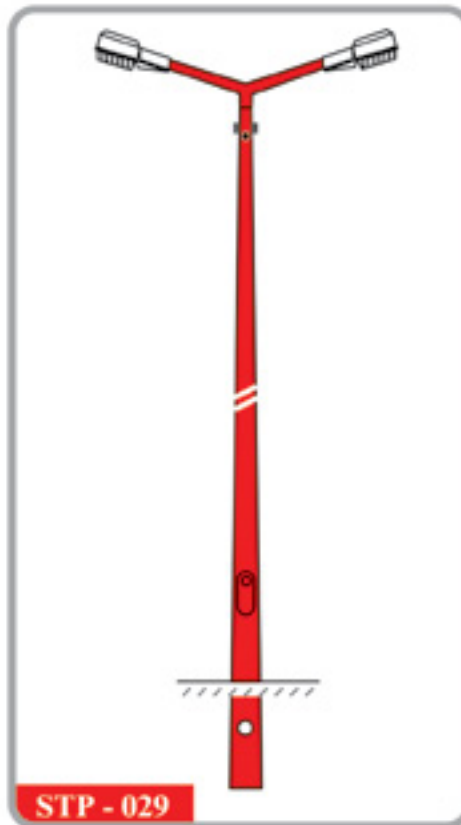
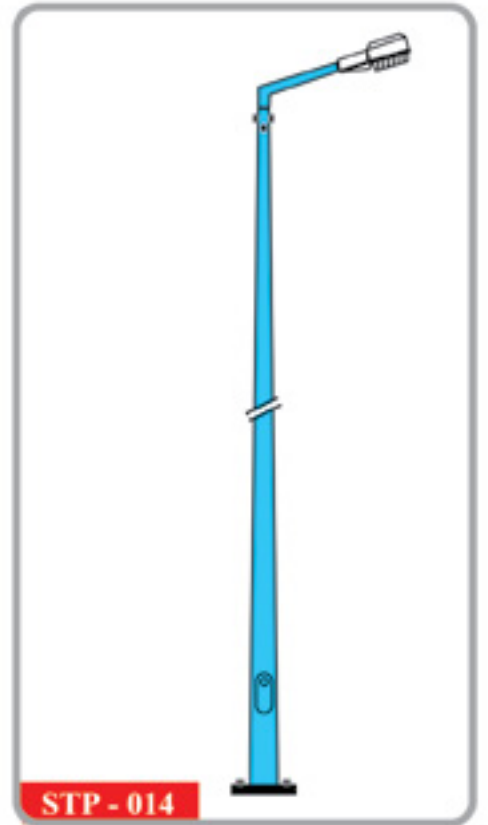
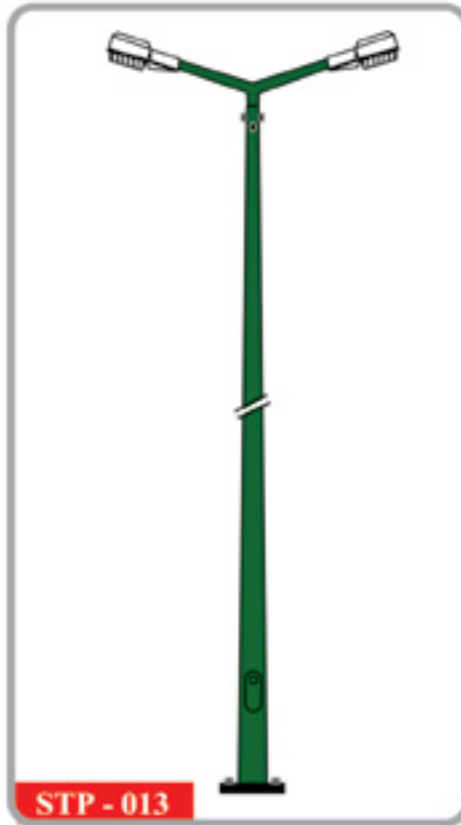
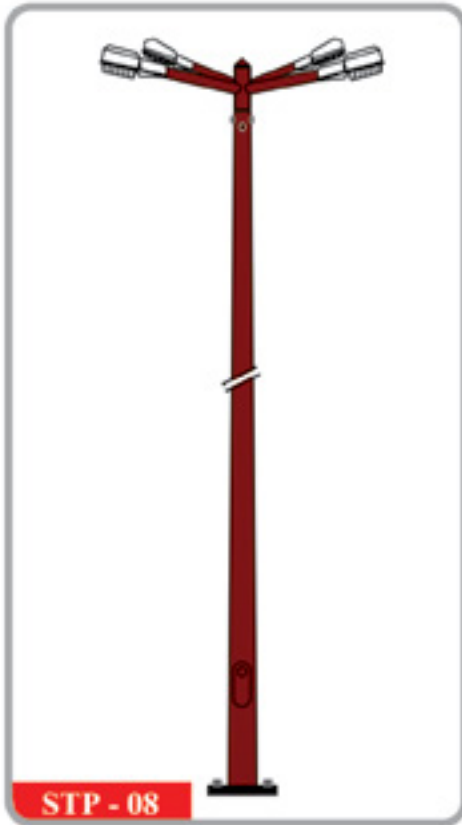

■ Street Lighting Poles

■ أعمدة إنارة الطرق

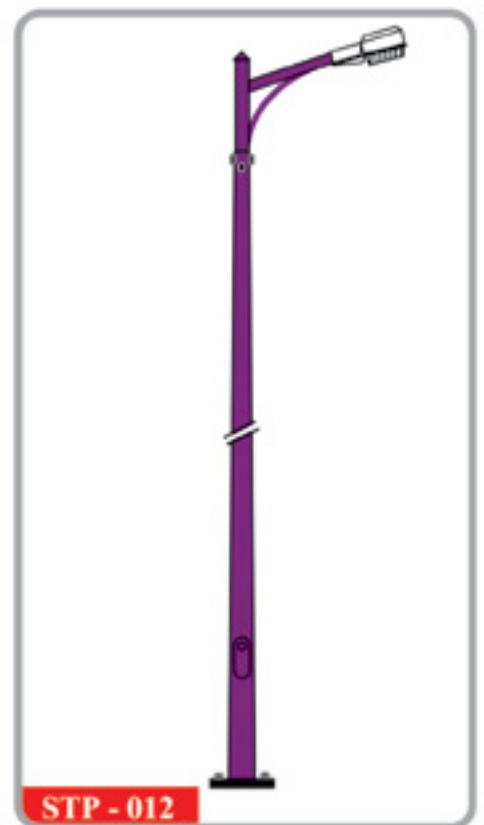
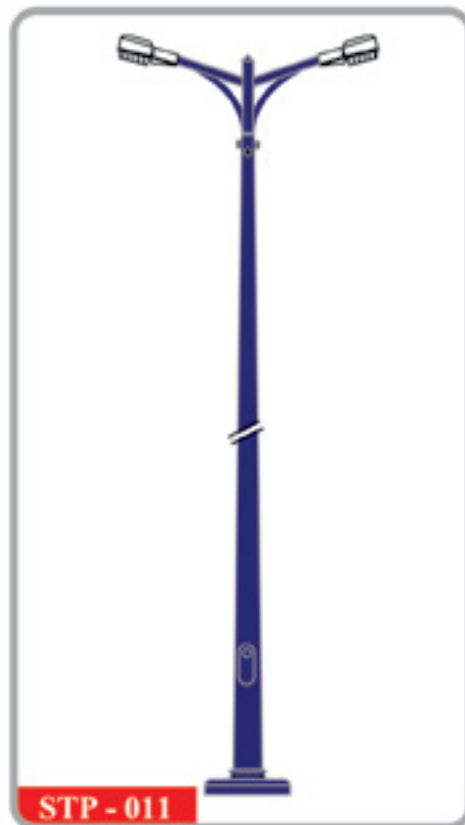
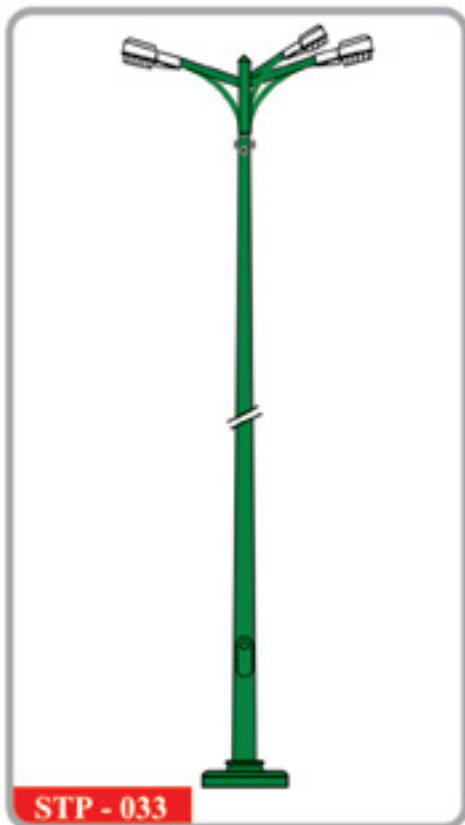
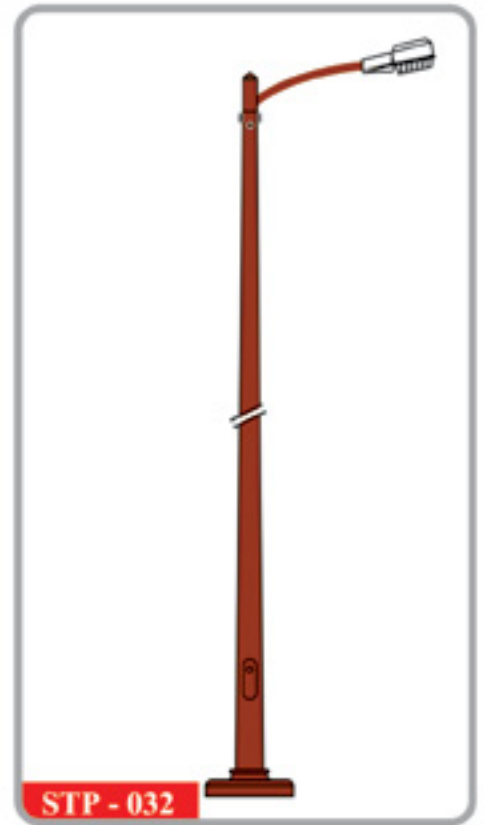
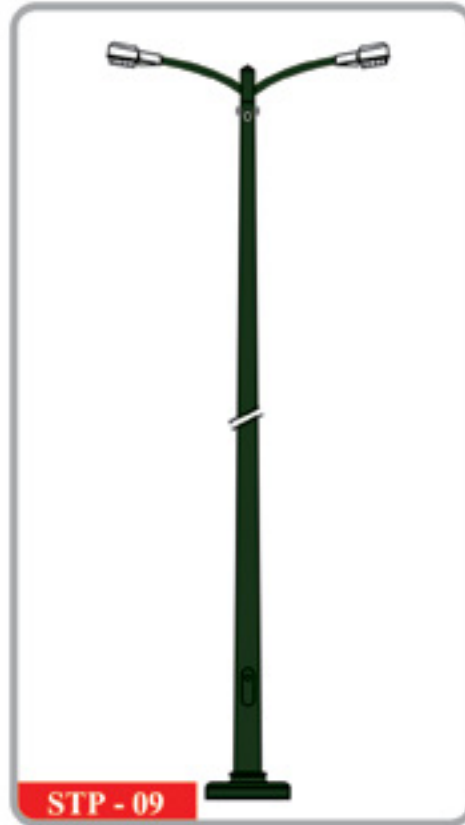
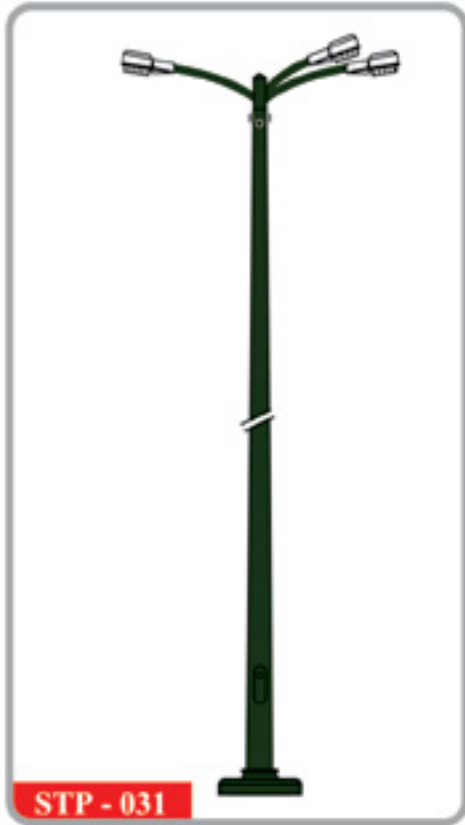

■ Street Lighting Poles

■ أعمدة إنارة الطرق

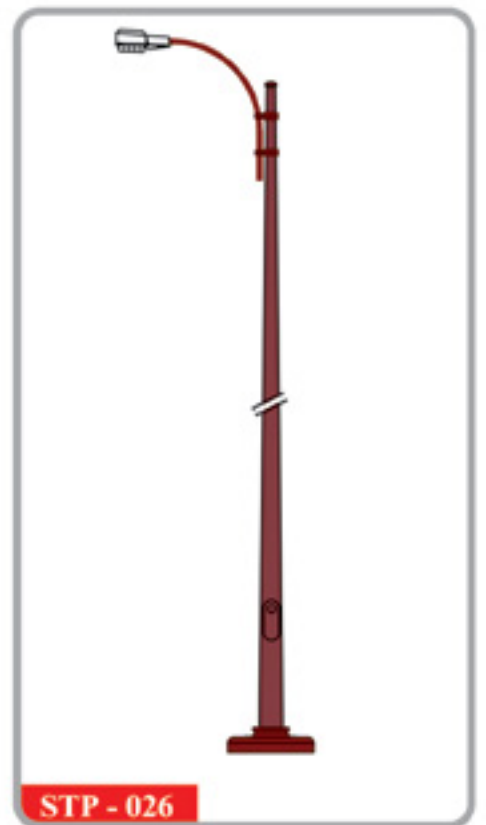
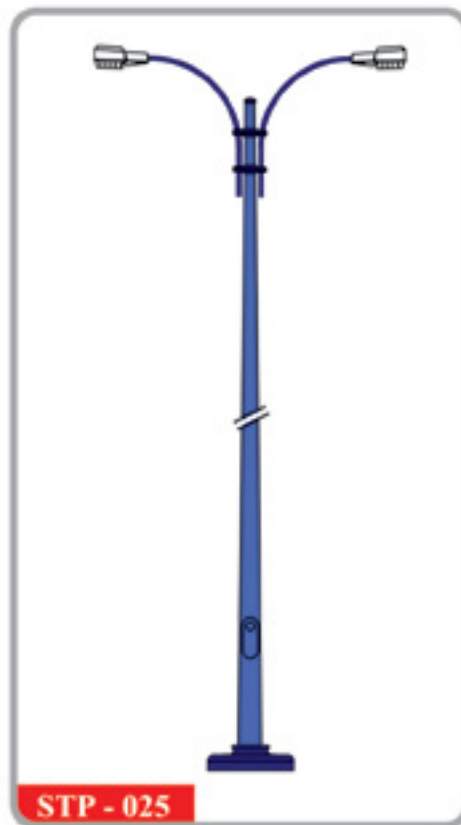
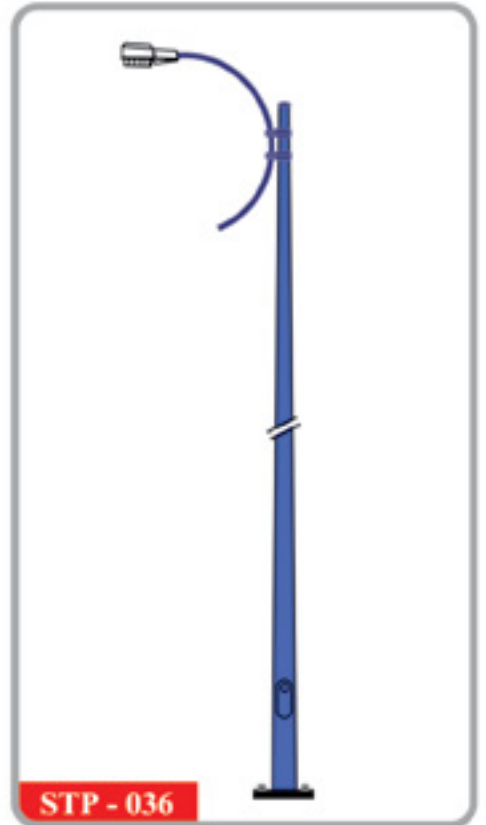
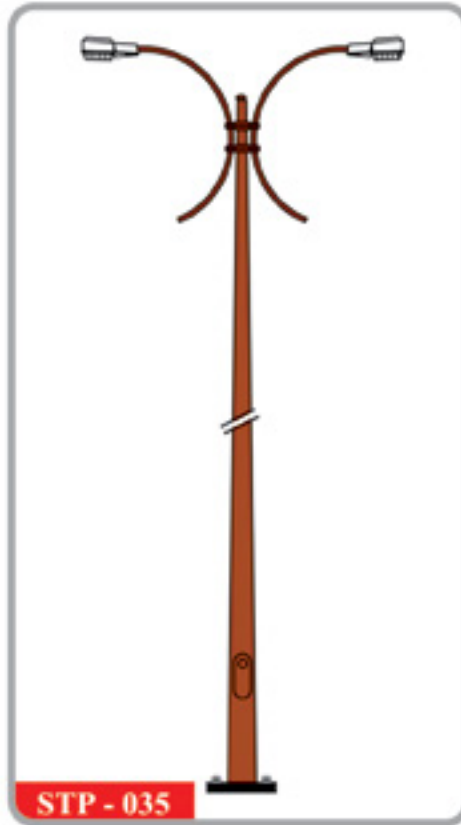

■ Street Lighting Poles

■ أعمدة إنارة الطرق

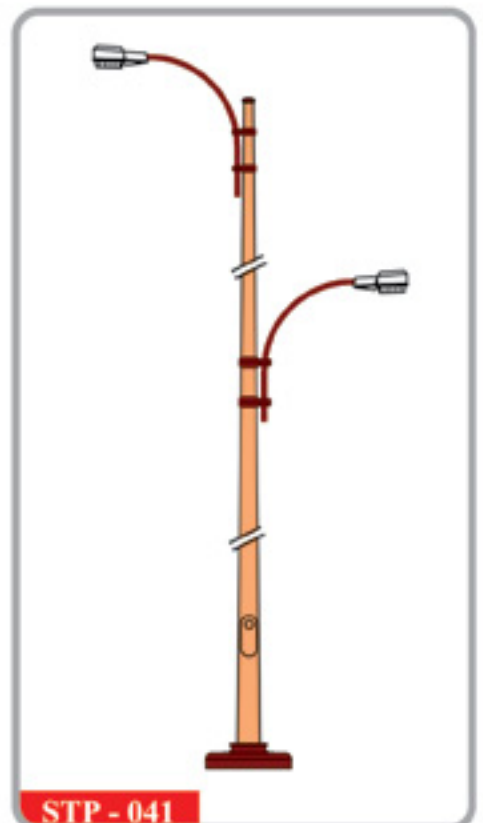
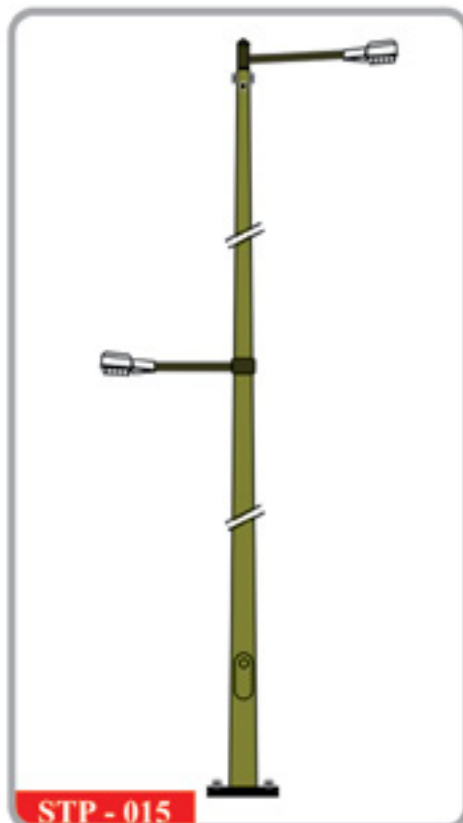
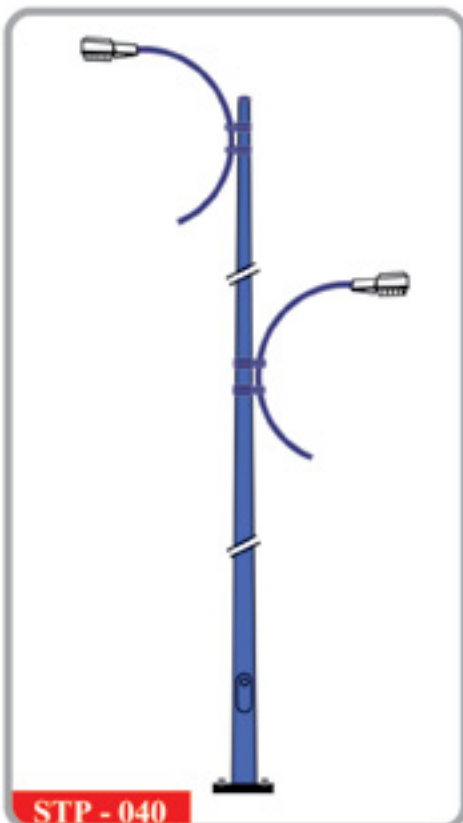
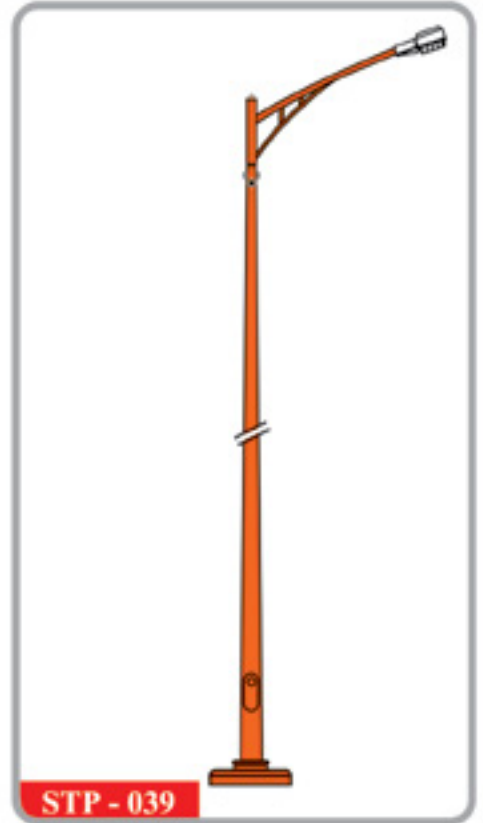
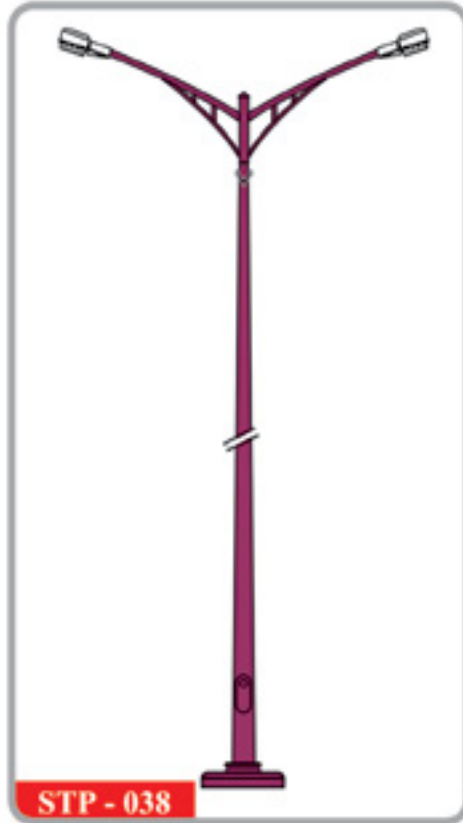

■ Decorative Lighting Poles

■ أعمدة إنارة ديكورية

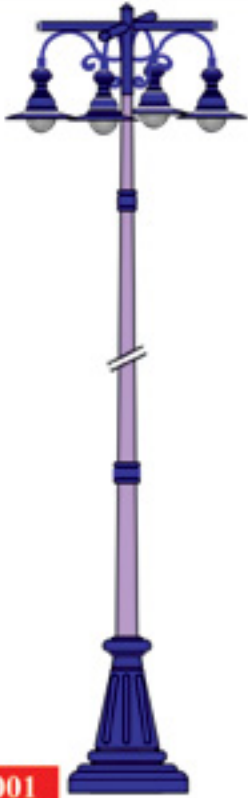

DCP - 001



DCP - 002



DCP - 003

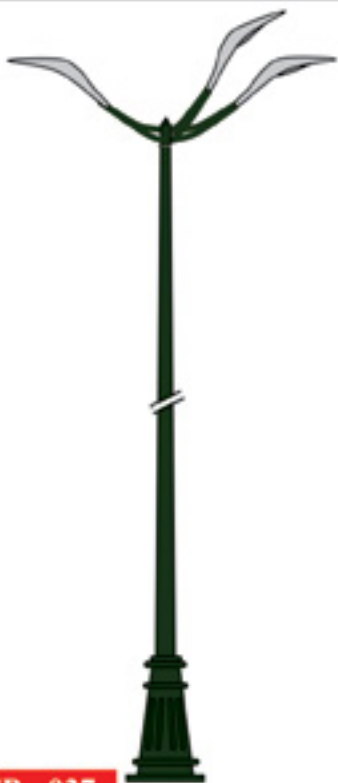

DCP - 037



DCP - 005

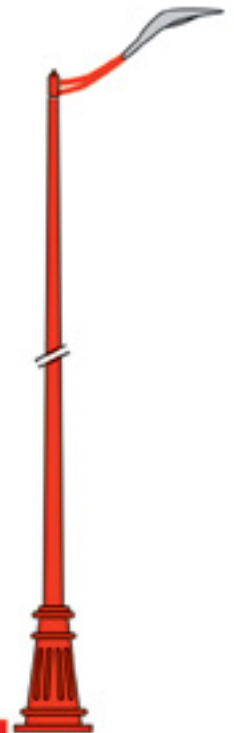

DCP - 004

■ Decorative Lighting Poles

■ أعمدة إنارة ديكورية

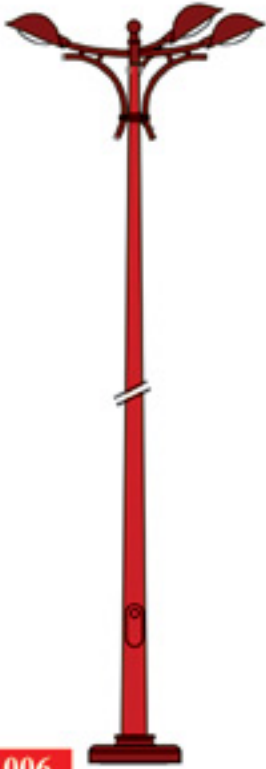

DCP - 006

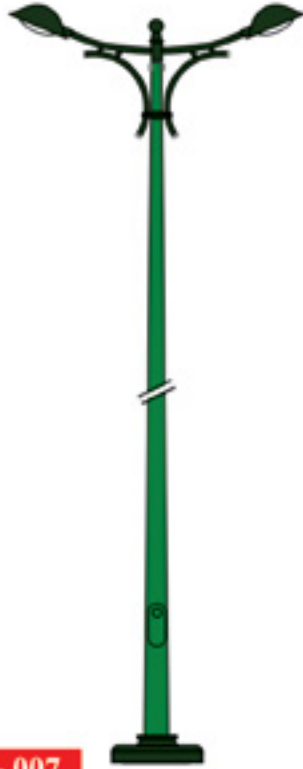

DCP - 007

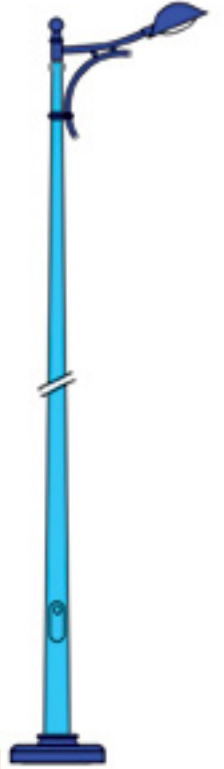

DCP - 008



DCP - 009



DCP - 038



DCP - 039

■ Decorative Lighting Poles

■ أعمدة إنارة ديكورية

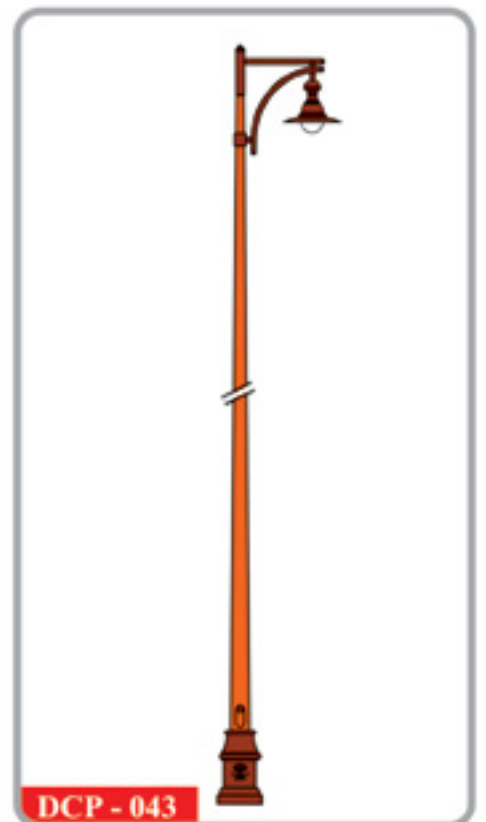
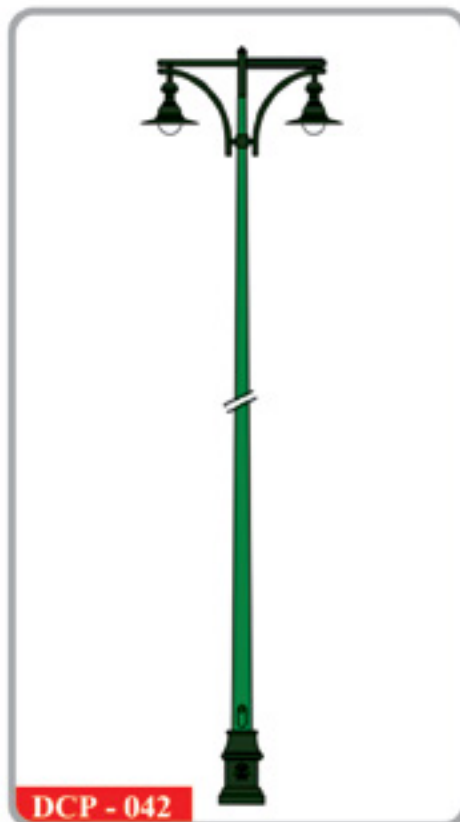
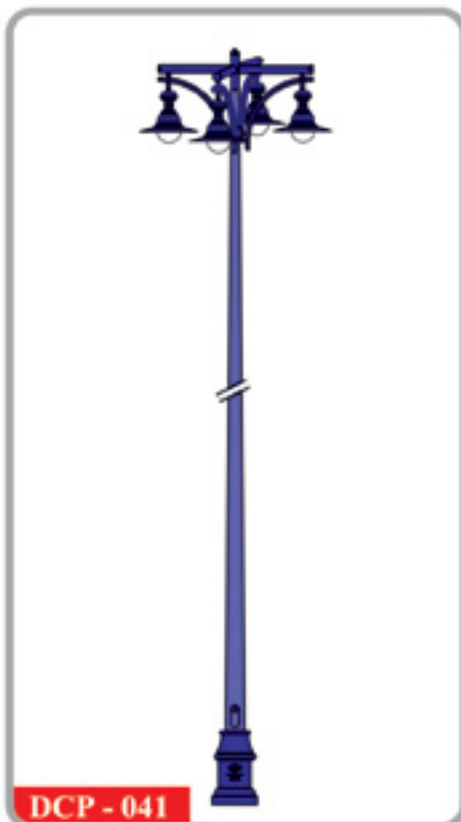
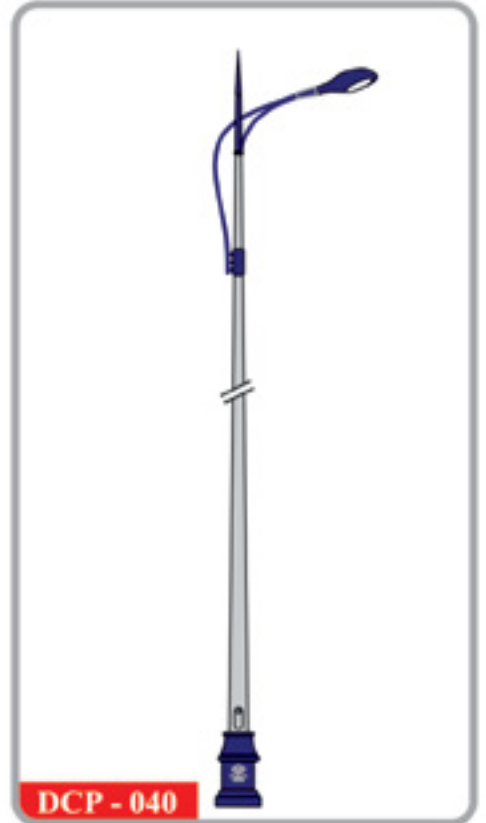
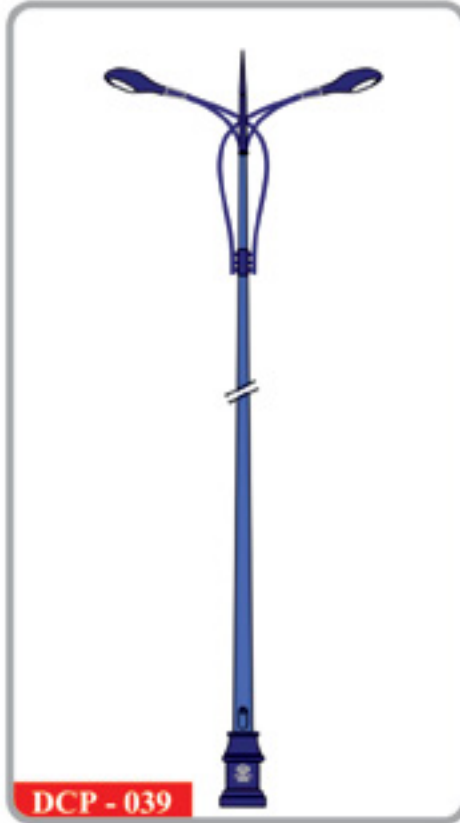

■ Decorative Lighting Poles

■ أعمدة إنارة ديكورية

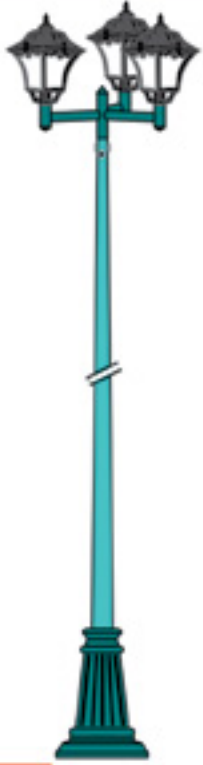

DCP-044

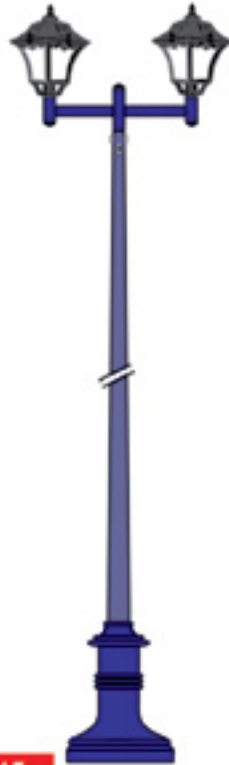

DCP-045



DCP-014

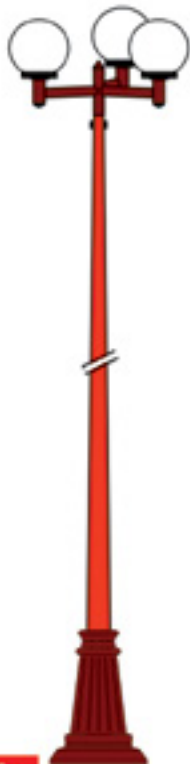

DCP-022

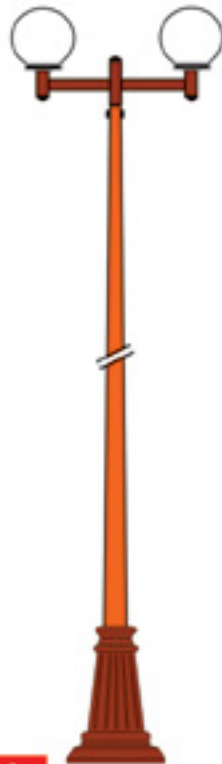

DCP-023

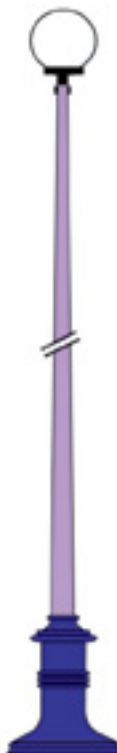

DCP-025

■ Decorative Lighting Poles

■ أعمدة إنارة ديكورية



DCP-016

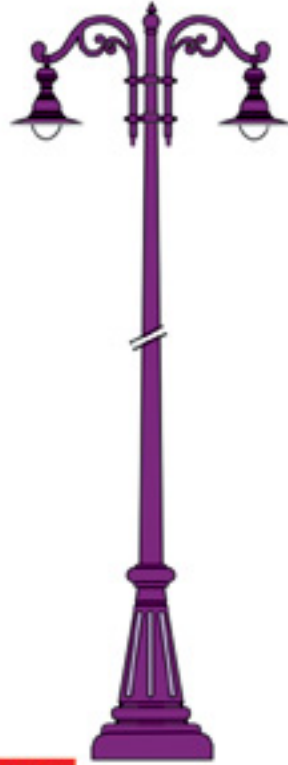

DCP-017

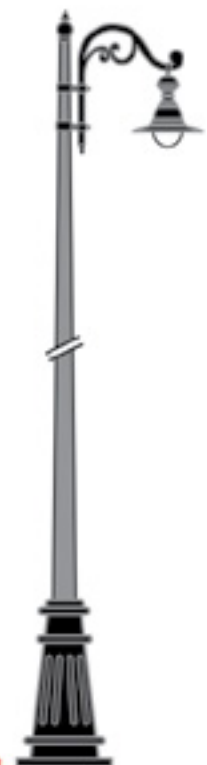

DCP-018

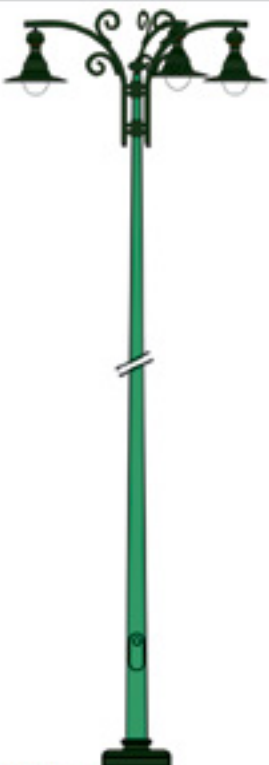

DCP-046

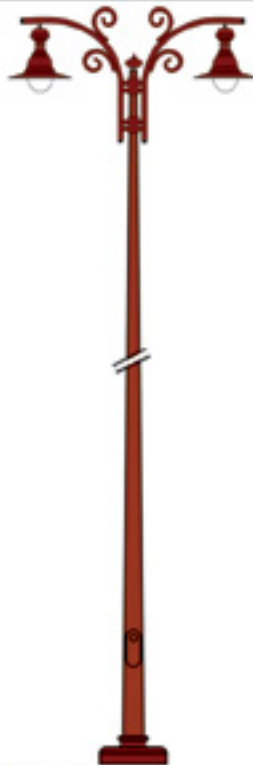

DCP-019



DCP-057

■ Decorative Lighting Poles

■ أعمدة إنارة ديكورية



DCP-048

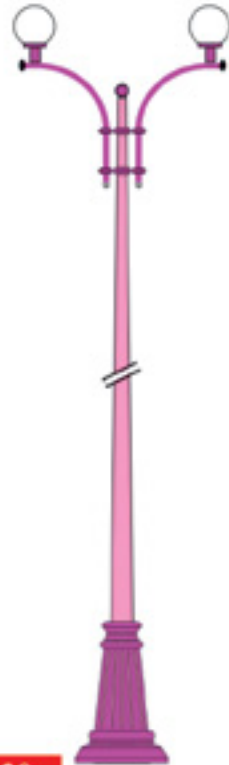

DCP-020



DCP-049



DCP-050

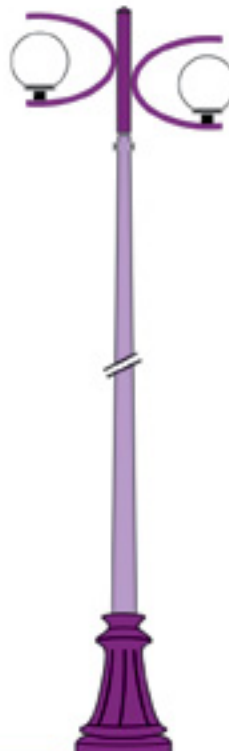

DCP-030

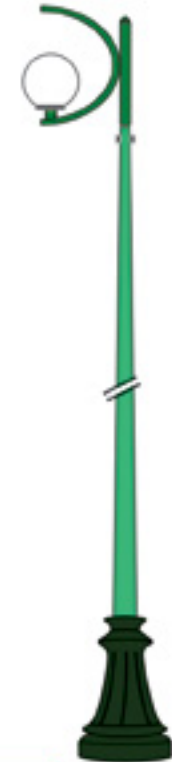

DCP-031

■ Decorative Lighting Poles

■ أعمدة إنارة ديكورية

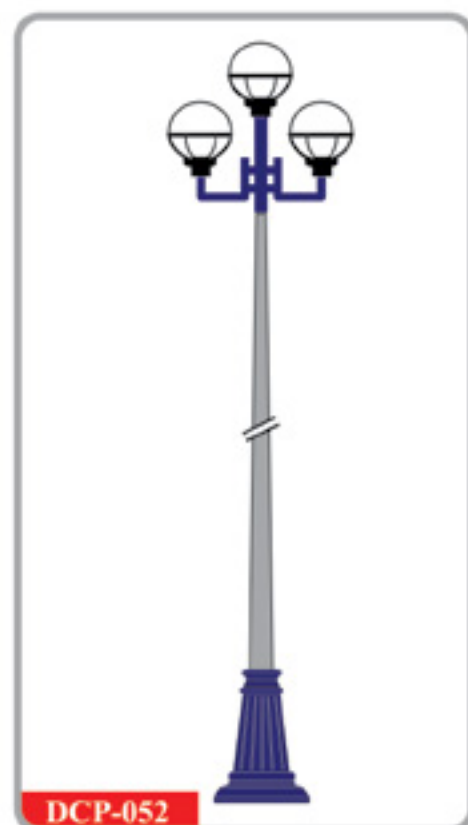
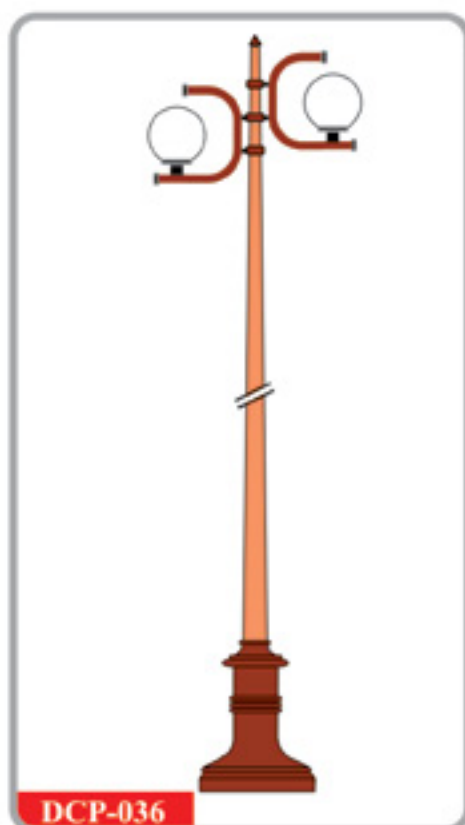
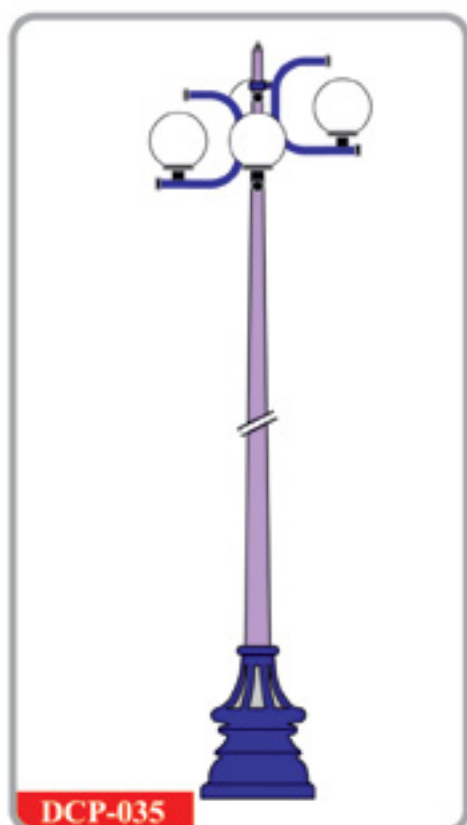
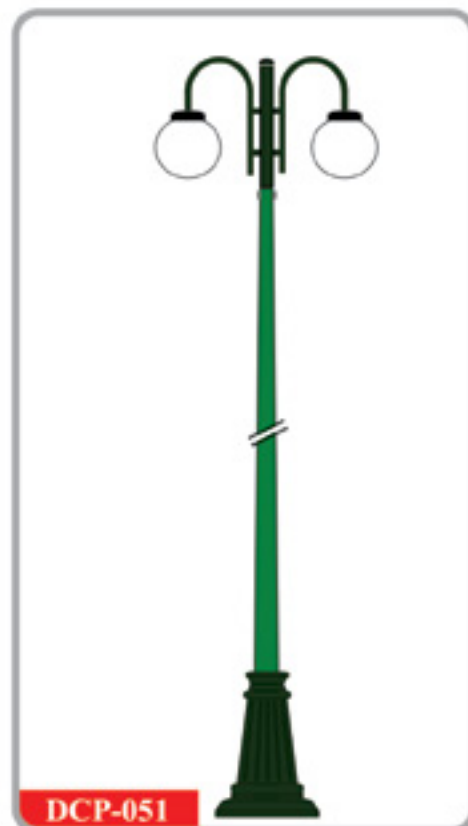
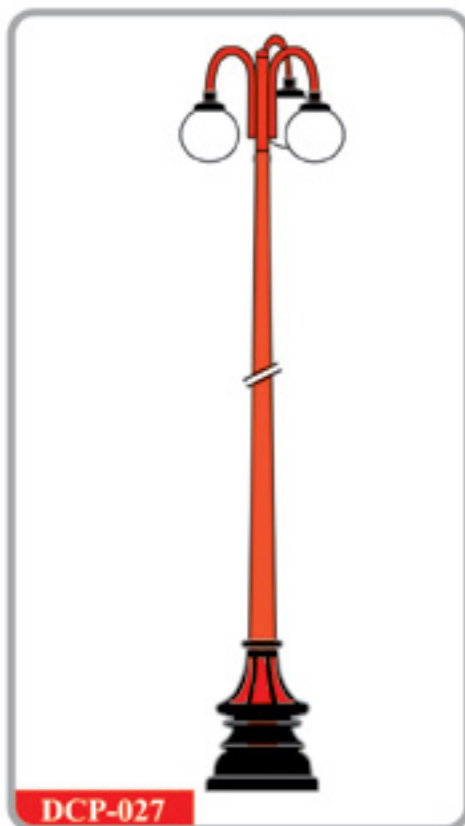
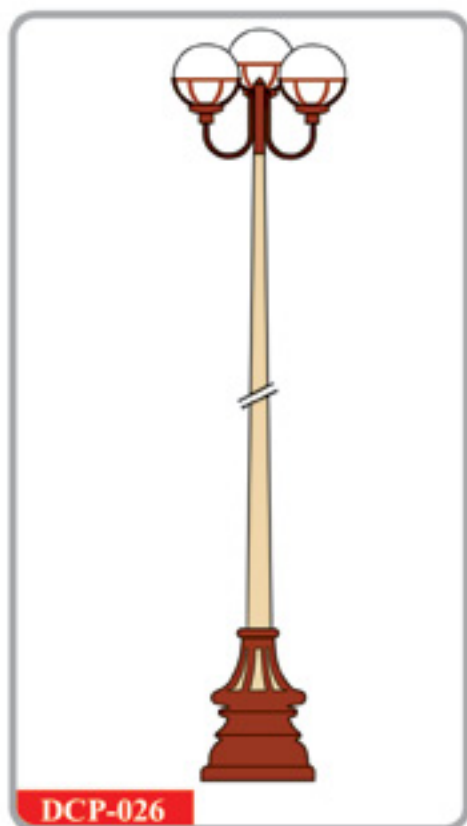

■ Decorative Lighting Poles

■ أعمدة إنارة ديكورية

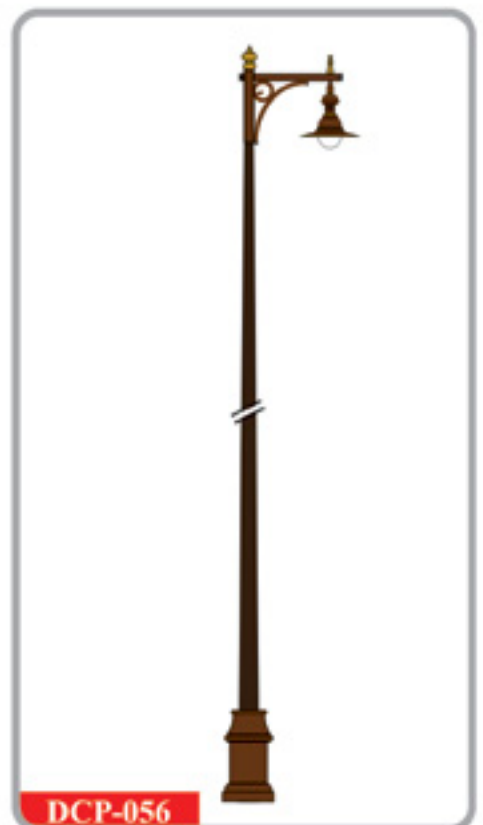
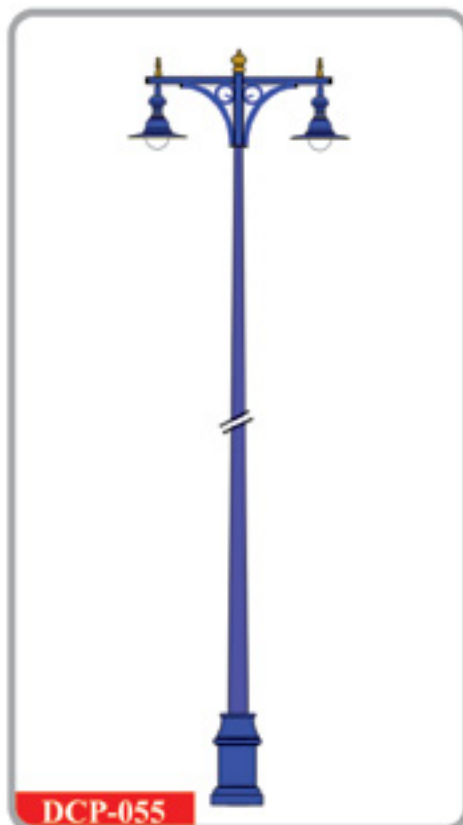
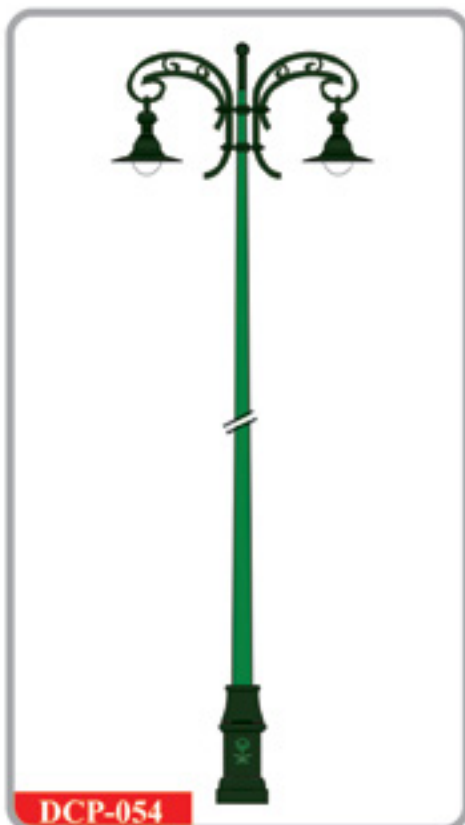
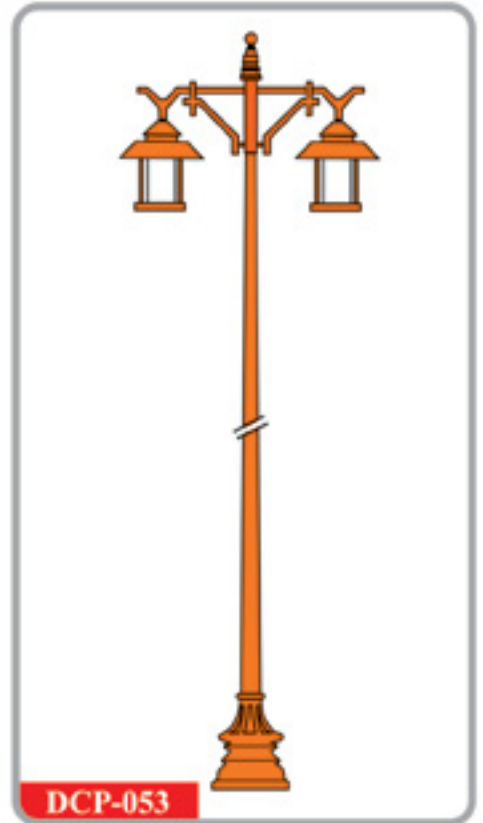
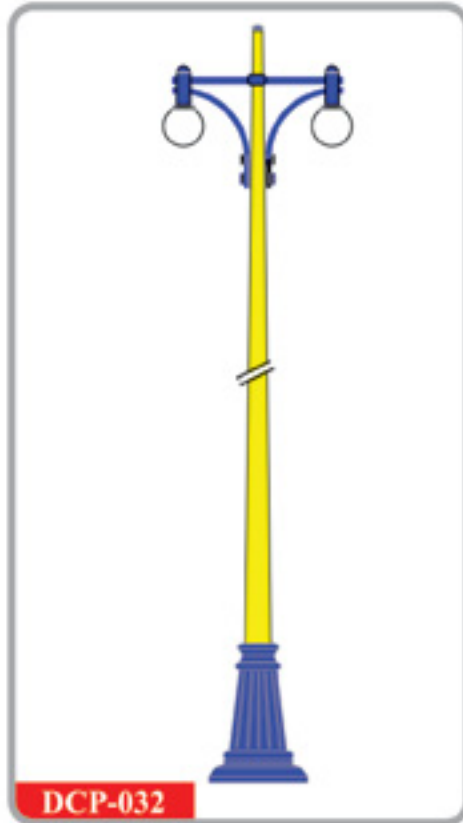
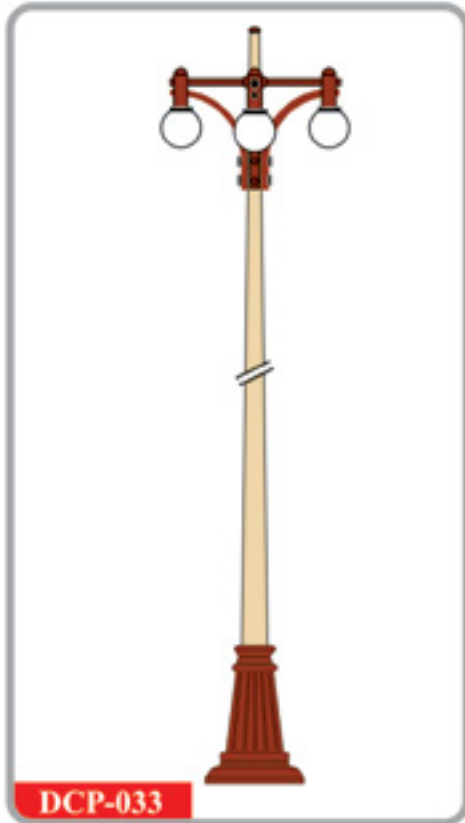

■ Solar Lighting Poles

■ أعمدة إنارة بالطاقة الشمسية

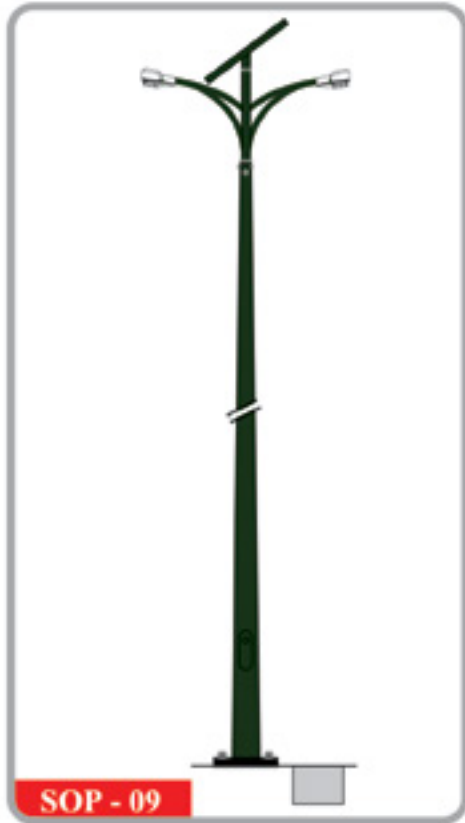

■ Solar Lighting Poles

■ أعمدة إنارة بالطاقة الشمسية

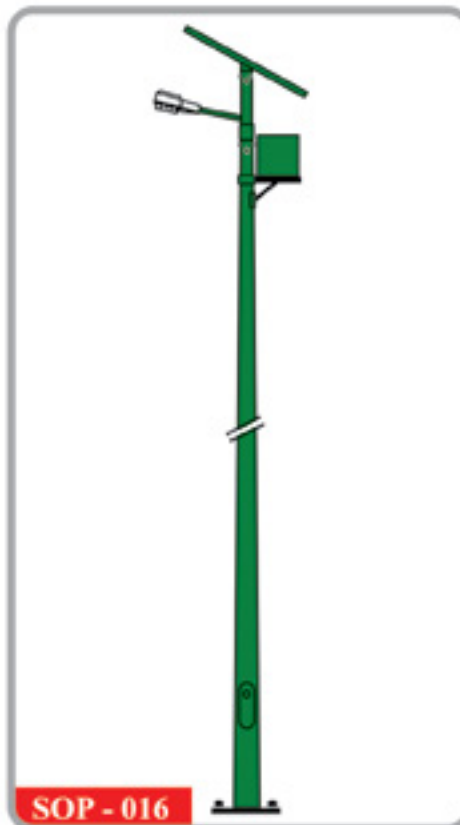
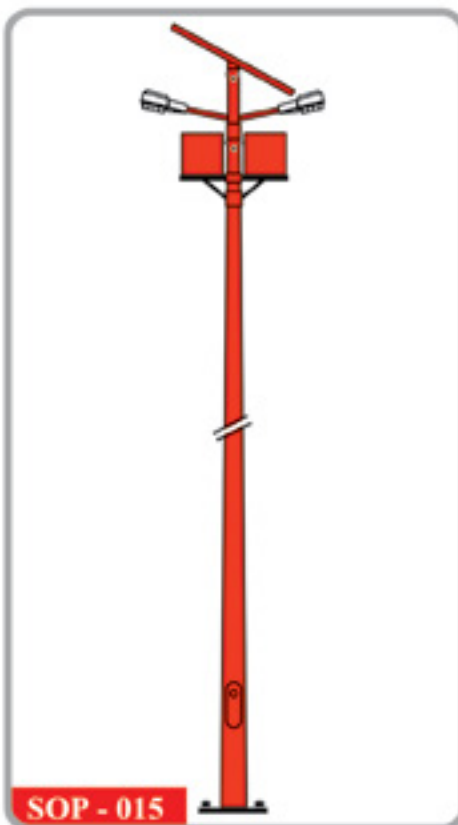
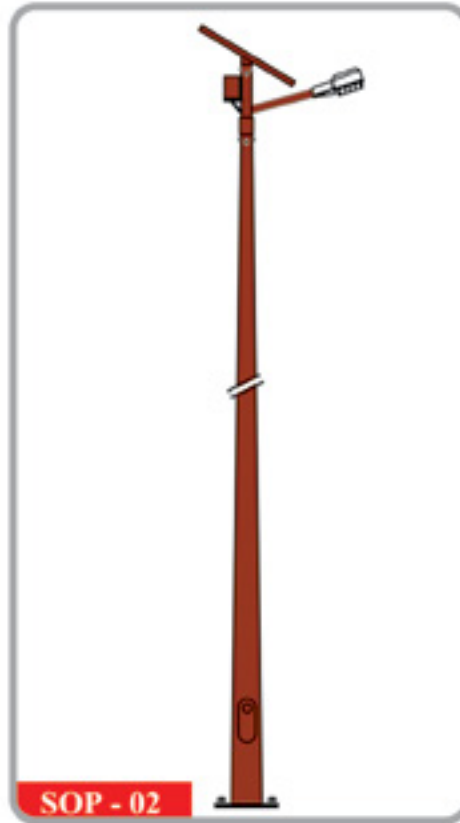
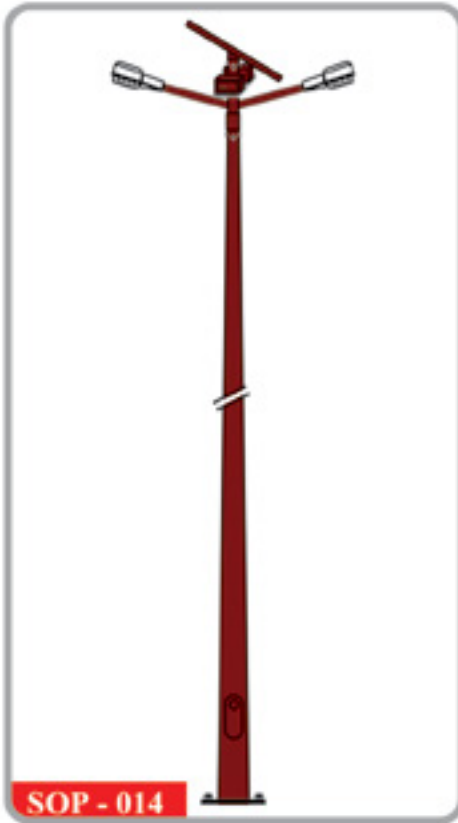

■ Solar Lighting Poles

■ أعمدة إنارة بالطاقة الشمسية

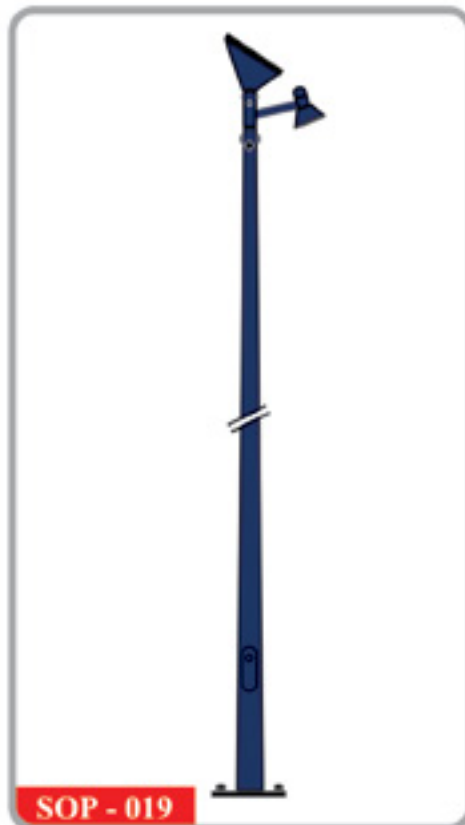
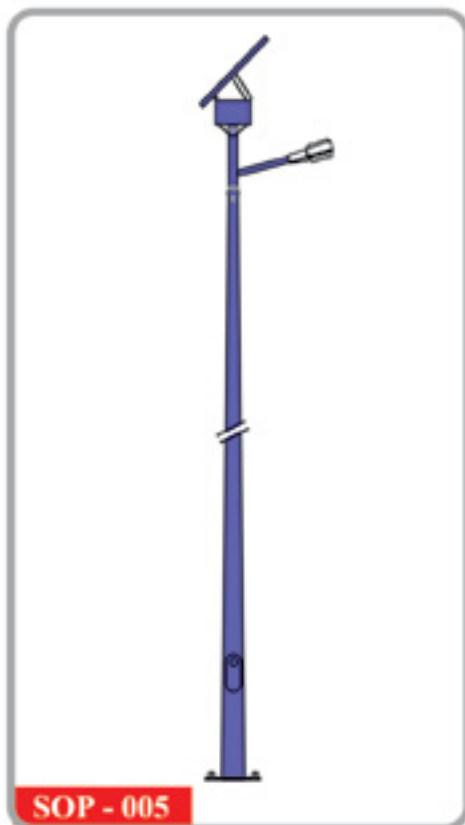
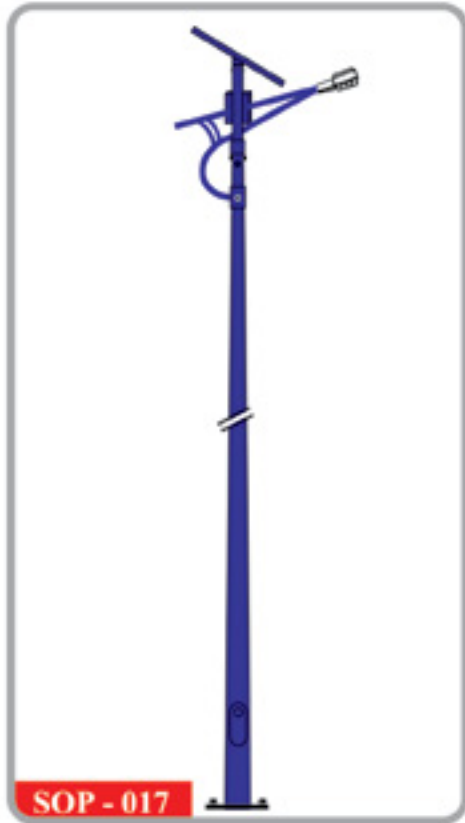

■ Flood Lighting Poles

■ أعمدة الأضواء الكاشفة

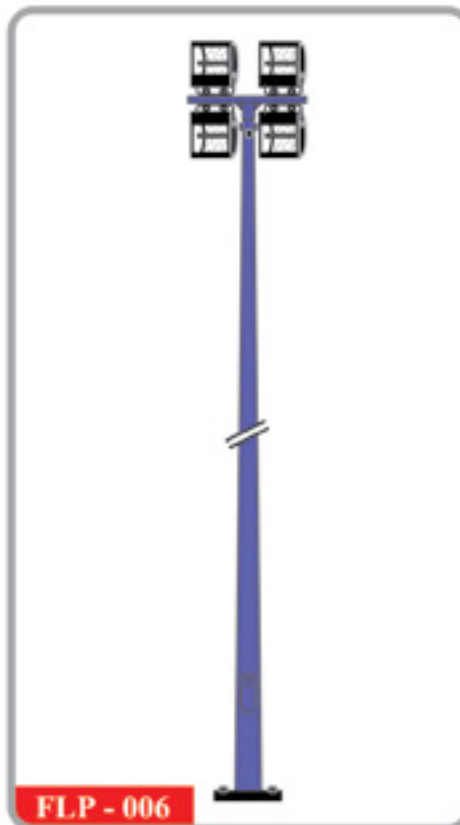
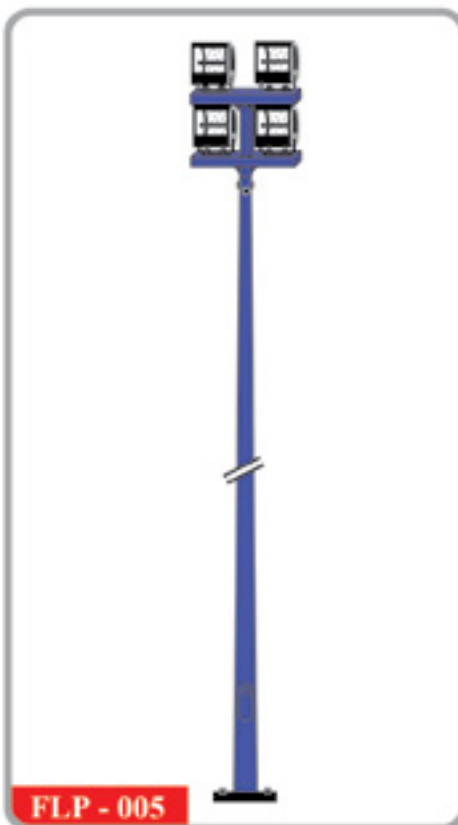
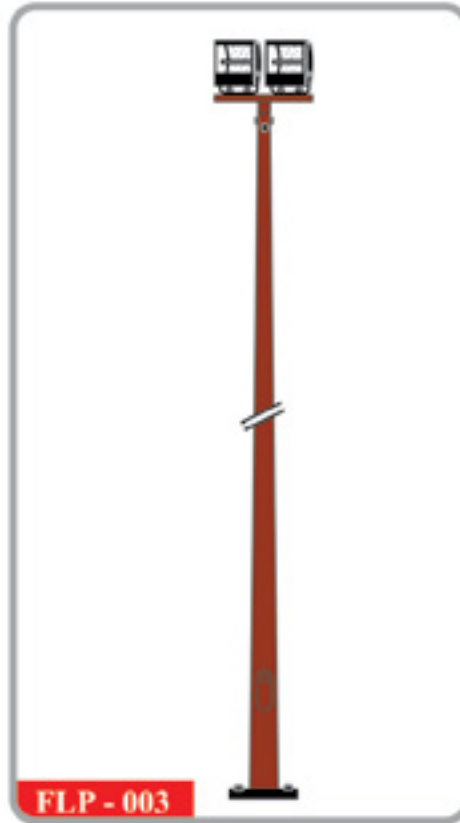
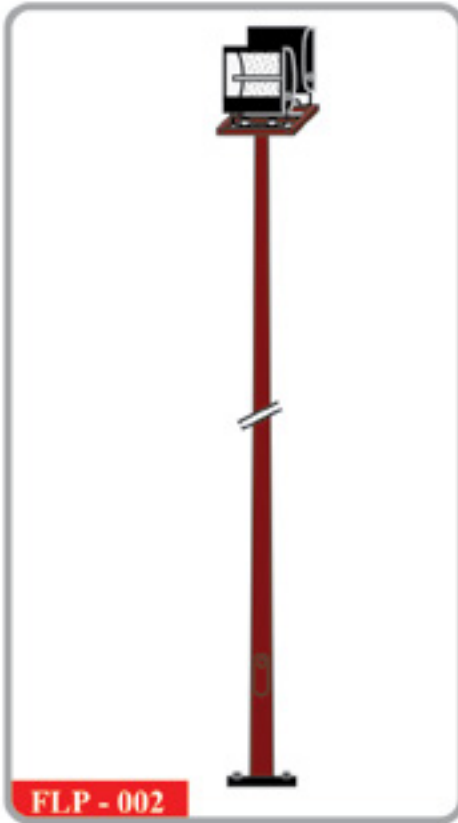

■ Flood Lighting Poles

■ أعمدة الأضواء الكاشفة

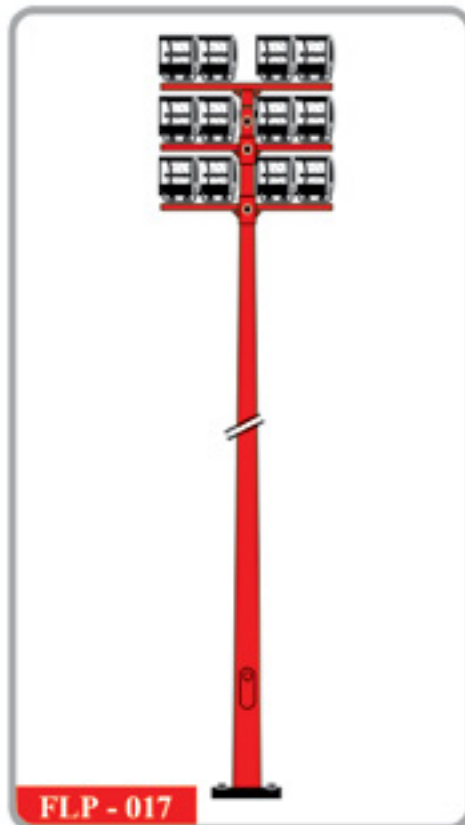
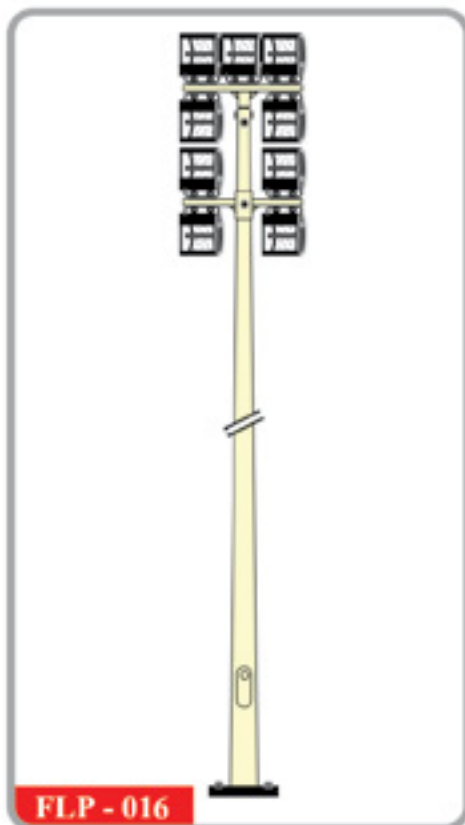

■ Flood Lighting Poles

■ أعمدة الأضواء الكاشفة

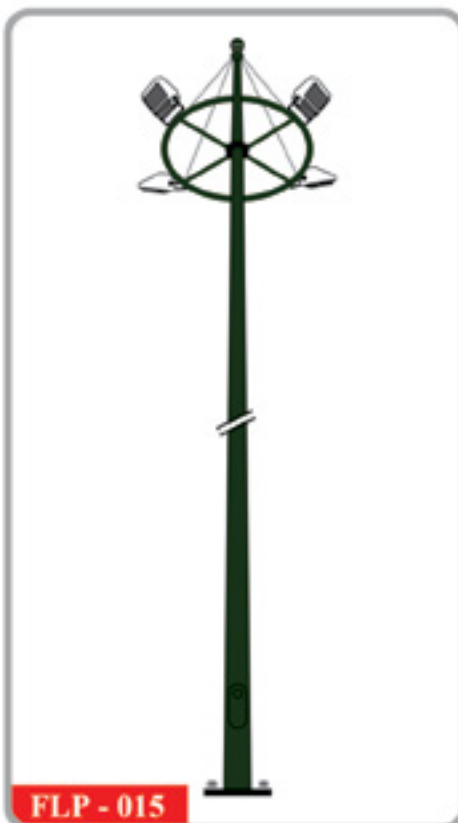
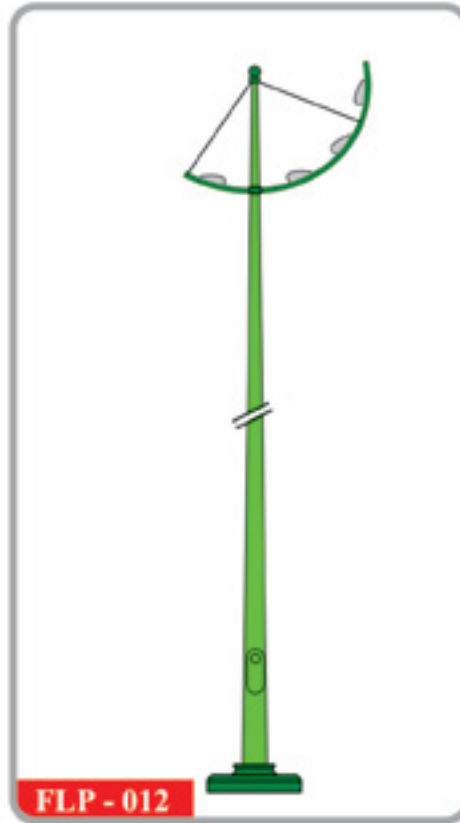

■ Flag Poles

■ أعمدة الأعلام

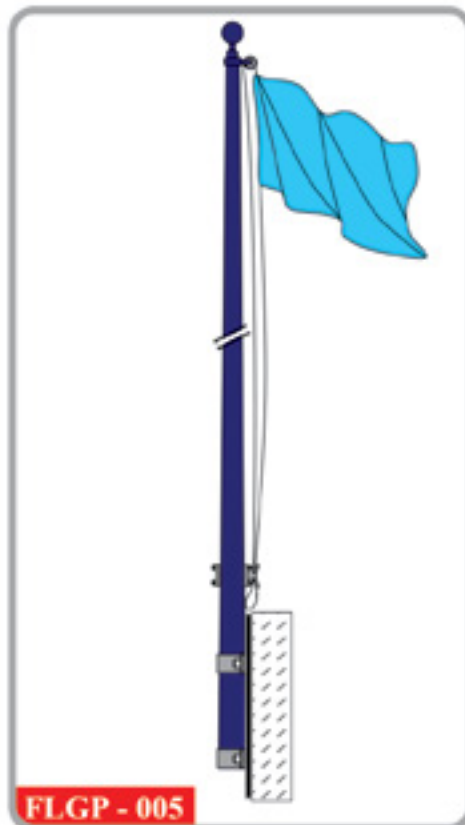
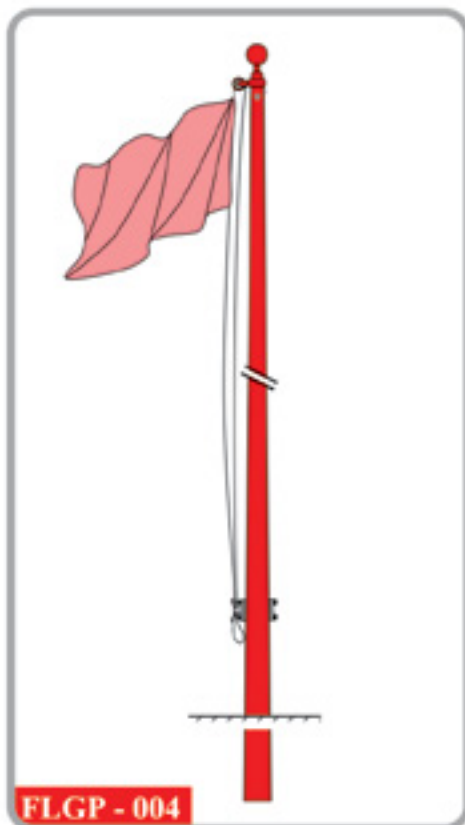
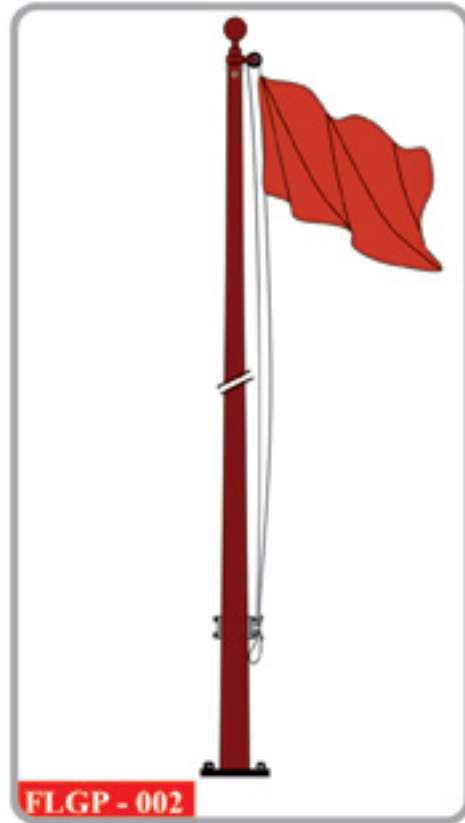

■ Traffic and signs Carrier Poles

■ أعمدة إشارات المرور والإعلانات

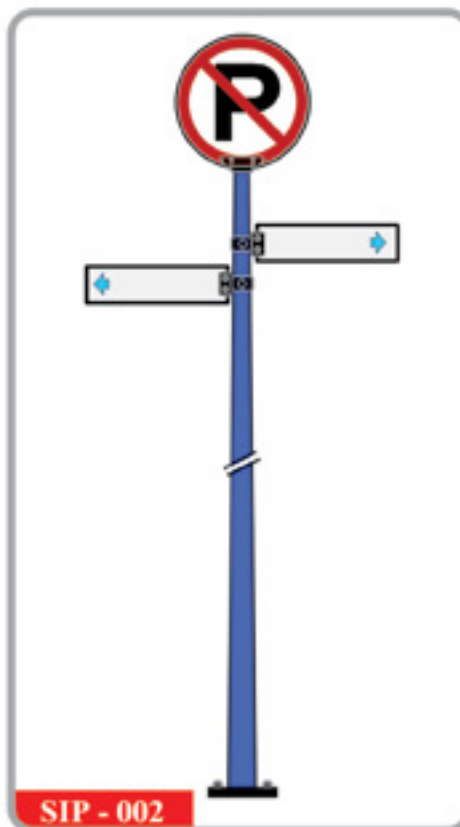
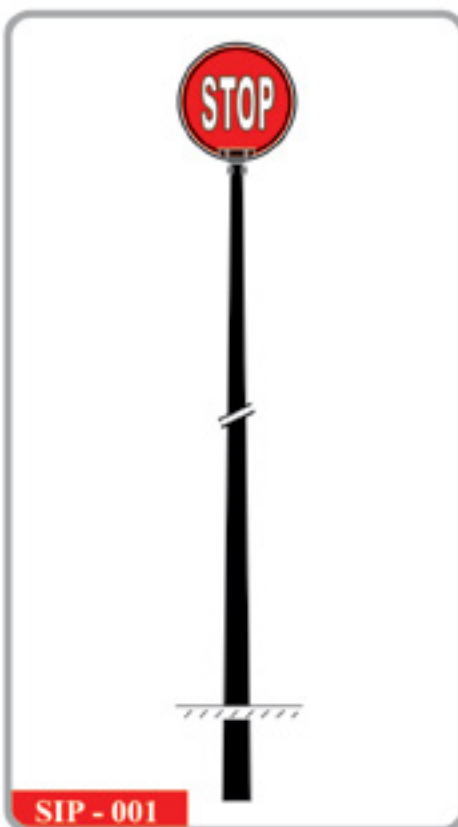

■ Power Transmission Poles

■ أعمدة نقل الطاقة

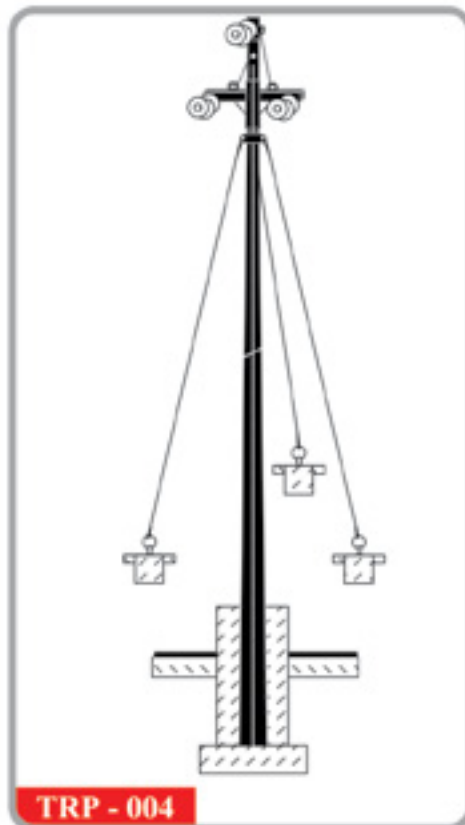
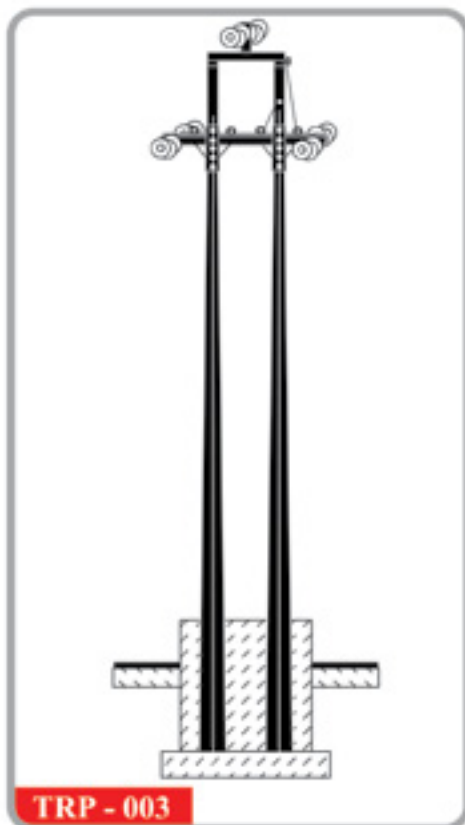
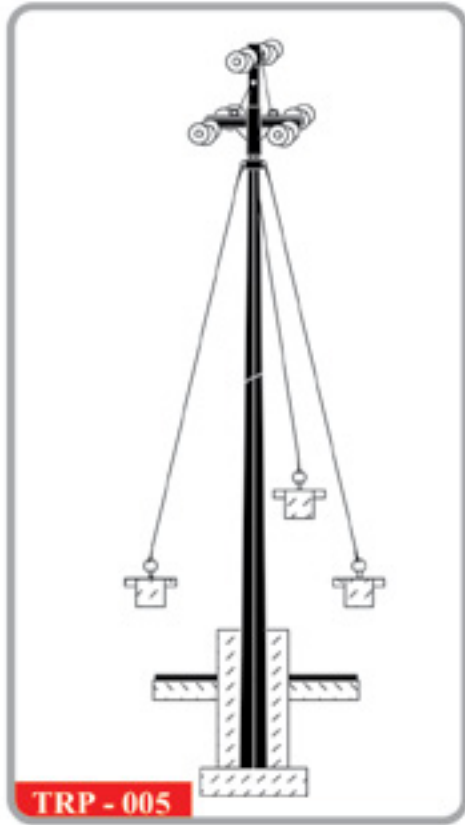

■ Street Poles Arms

■ أذرع أعمدة طرق



■ Street Poles Arms

■ أذرع أعمدة طرق

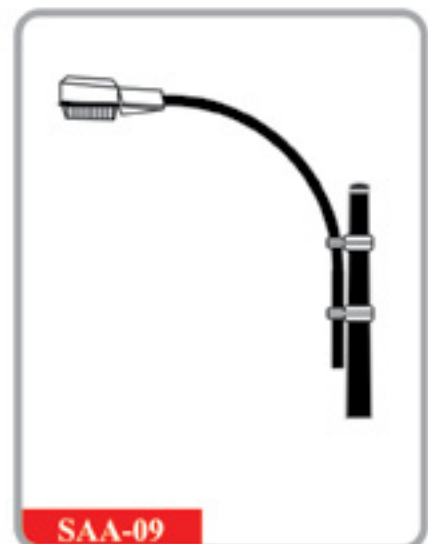

■ Street Poles Arms

■ أذرع أعمدة طرق

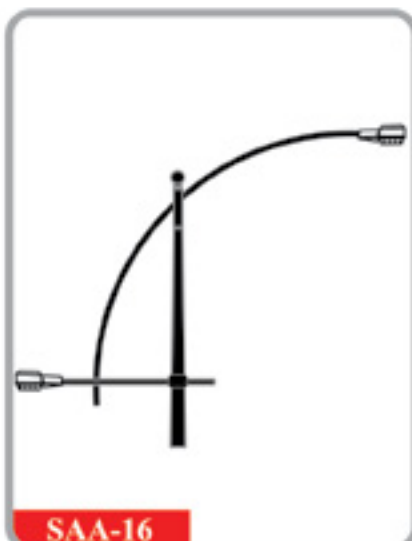
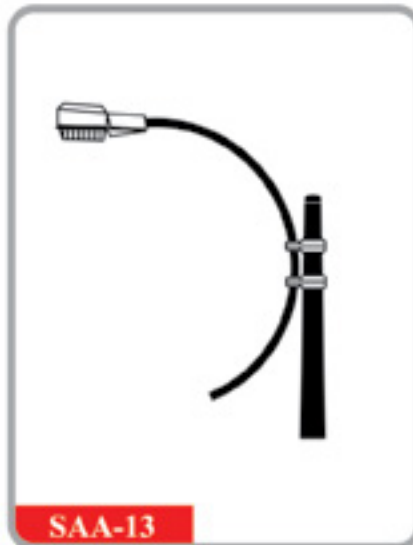

■ Decorative Arms

■ أذرع ديكورية

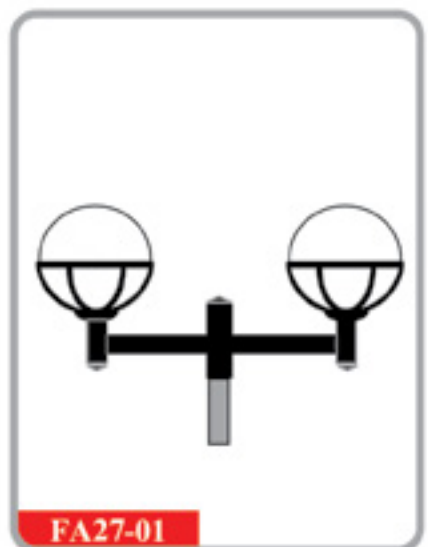
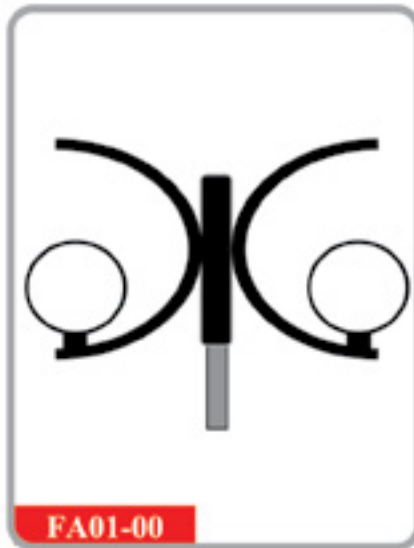

■ Decorative Arms

■ أذرع ديكورية

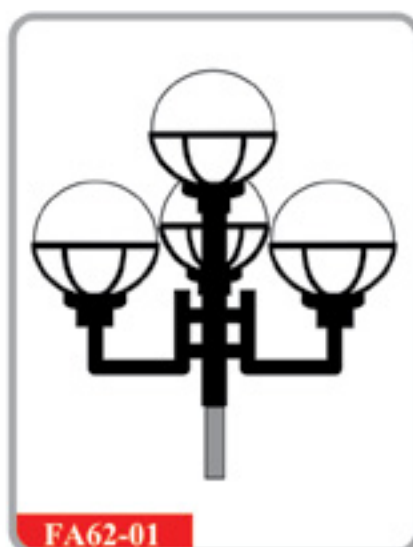
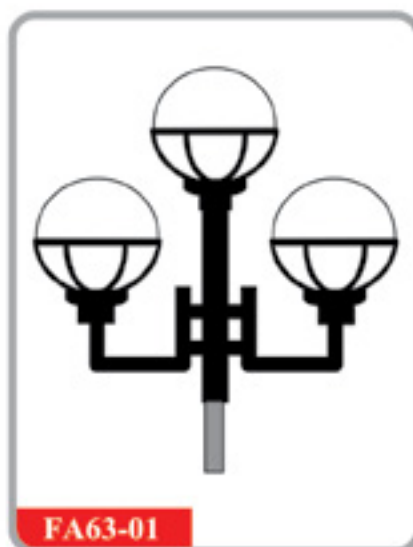
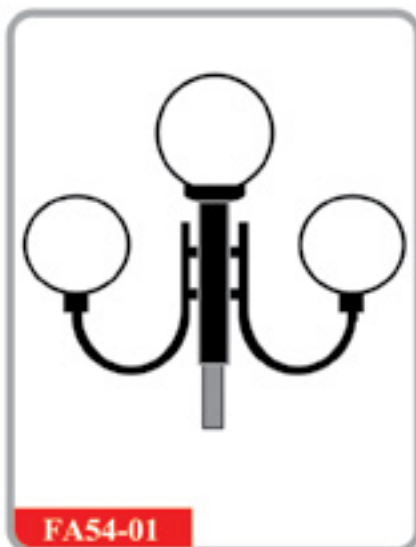
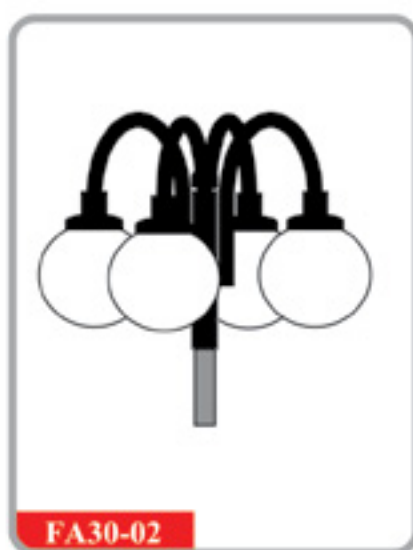
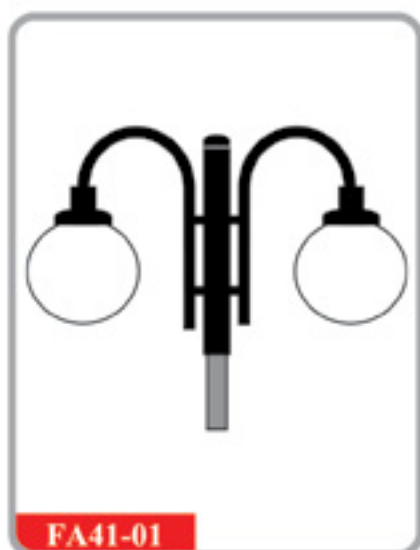

■ Decorative Arms

■ أذرع ديكورية

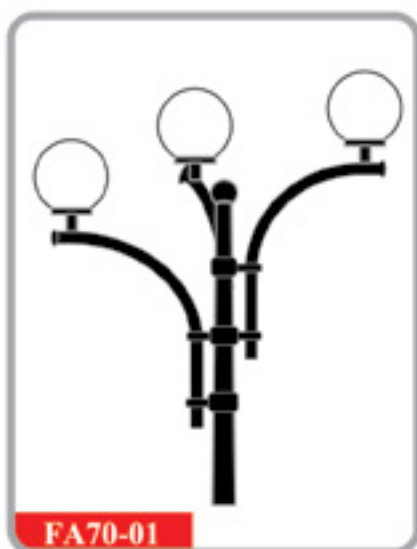
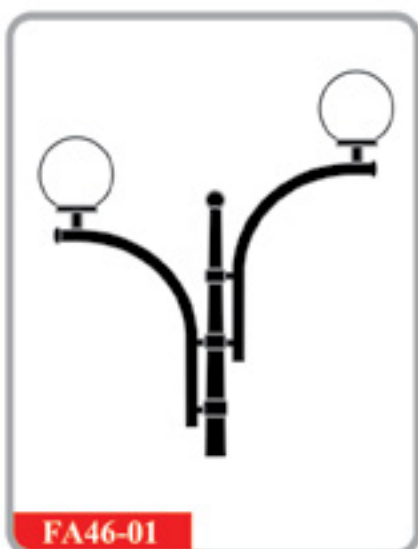
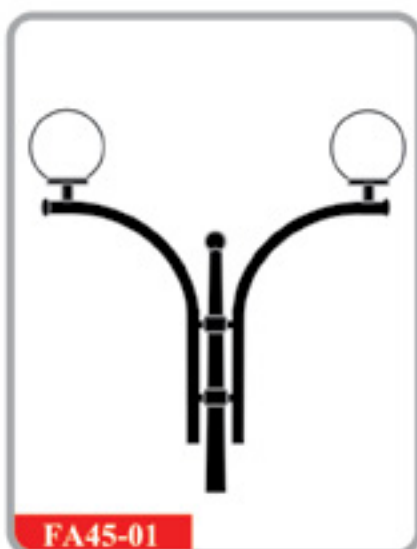
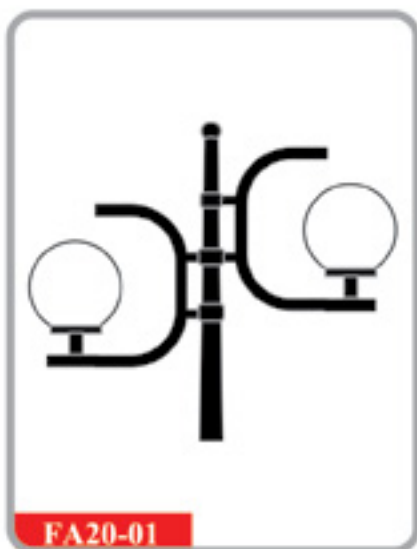

■ Decorative Arms

■ أذرع ديكورية



■ Decorative Arms

■ أذرع ديكورية



■ Decorative Arms

■ أذرع ديكورية



■ Decorative Arms

■ أذرع ديكورية



■ Flood Lighting Arms

■ أذرع إضاءة كاشفة



FA14-04



FA14-01A



FA14-01B



FA14-09A



FA14-09B



FA14-09C

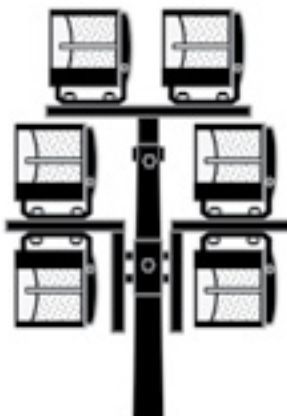

FA16-01

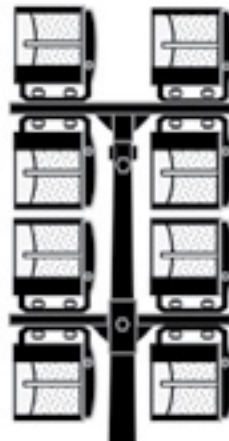

FA53-01

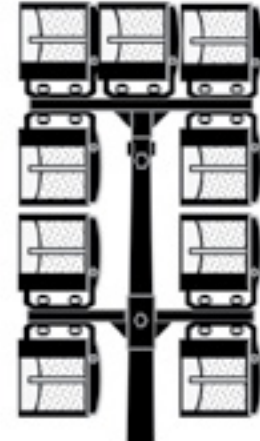

FA52-01

■ Flood Lighting Arms

■ أذرع إضاءة كاشفة

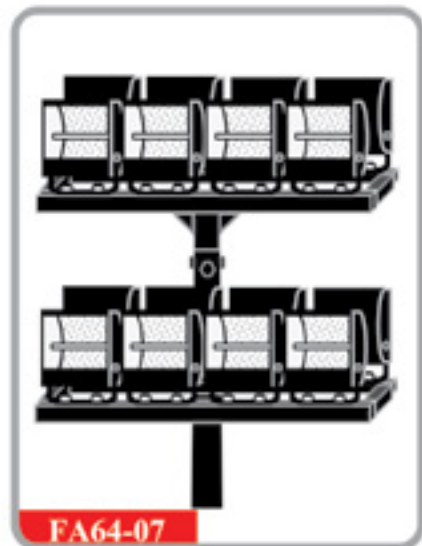
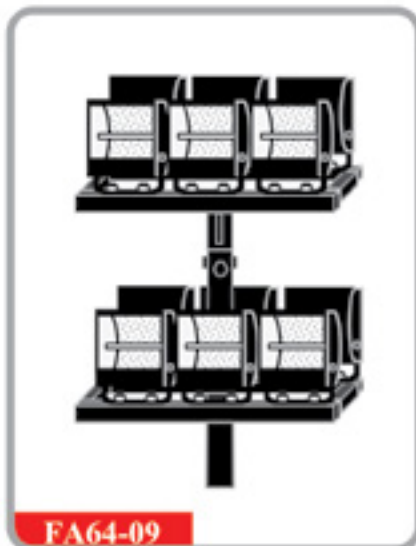
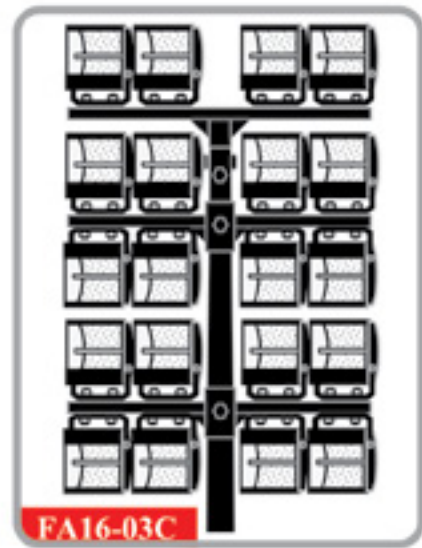

■ Flood Lighting Arms

■ أذرع إضاءة كاشفة

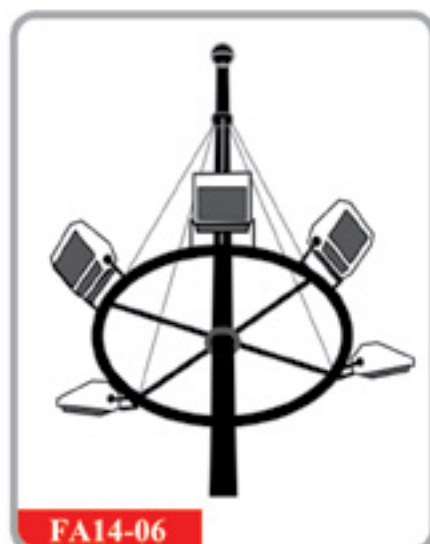

■ Decorative Bases

■ قواعد ديكورية



FB-01



FB-02



FB-03



FB-04



FB-05



FB-06



FB-07



FB-08

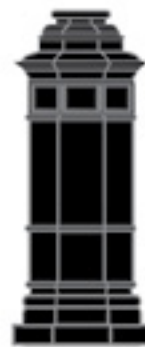

FB-10

■ Decorative Bases

■ قواعد ديكورية



FB-12



FB-16



FB-18



FB-13



FB-15



FB-11



FB-19



FB-20



FB-21

■ Decorative Bases

■ قواعد ديكورية



FB-22



FB-23



FB-24



FB-25



FB-26



FB-27

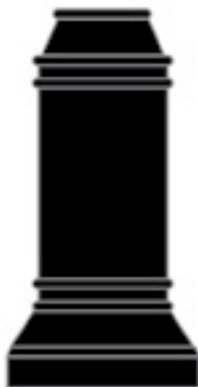

FB-28



FB-30



FB-31

■ Decorative Bases

■ قواعد ديكورية

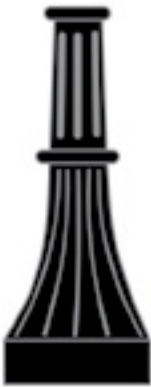

FB-32



FB-33



FB-34



FB-35



FB-37



FB-38



FB-40



FB-29

■ Dimensions of Decorative Bases

■ أبعاد القواعد الديكورية

Code	Pole Length (mm)																	Base Dim.(mm)						
	2500	3000	3500	4000	4500	5000	5500	6000	6500	7000	7500	8000	8500	9000	9500	10000	11000	12000	13000	14000	H	W		
FB01																						550	500	
																							750	500
FB02																							550	500
FB03																							600	450
FB04																							500	400
																							600	450
FB05																							600	450
FB06																							600	450
FB07																							1000	550
FB08																							1250	450
FB10																							800	450
																							1000	550
																							1500	800
FB11																							200	650
																							200	450
FB12																							1200	650
FB13																							900	550
FB15																							1200	600
																							1200	600
																							1500	630
																							1550	850
FB16																							1200	500
FB18																							2200	700
																							1750	650
FB19																							1250	500
FB20																							1000	500
FB21																							1900	600
																							1900	450
																							1800	700
FB22																							1550	750
FB23																							1250	450
FB24																							2200	855
FB25																							1209	720
FB26																							1200	750
FB27																							2200	1000
FB28																							1200	600
FB29																							4000	520
FB30																							800	600
FB31																							1200	600
FB32																							1200	600
FB33																							1500	650
FB34																							1200	600
FB35																							1500	550
FB37																							2250	850
FB38																							1250	400
FB40																							950	600

■ 90th Street Bridge - New Cairo

■ كوبري شارع التسعين - القاهرة الجديدة



■ Al- Musheer Mosque - New Cairo

■ مسجد المشير - القاهرة الجديدة



■ Queens Royal Hospital - Cairo

■ مستشفى كوينز رويال - القاهرة



■ Petrosport Club

■ نادي بتروسبورت



■ Engineers Syndicate Club

■ نادي نقابة المهندسين



■ Al-Azhar Park

■ حديقة الأزهر



■ Beverly Hills

■ بيفرلي هيلز



■ Smart Village - Giza

■ القرية الذكية - الجيزة



■ Air Forces Hospital

■ المستشفى الجوي



■ Elain Elsokhna Highway

■ طريق العين السخنة



■ Egypt Alexandria Hightway

■ طريق مصر الإسكندرية الصحراوي



■ Elsalam Road Highway - Sharm Elsheikh

■ طريق السلام - شرم الشيخ



■ Bayt Elhamam - Sharm Elsheikh

■ قرية بيت الحمام - شرم الشيخ



■ Pharos University - Alexandria

■ جامعة فاروس - الإسكندرية



■ Alexandria Corniche

■ كورنيش الإسكندرية



■ Maamoura Corniche - Alexandria

■ كورنيش المعمورة - الإسكندرية



■ Marina - North Coast

■ مارينا - الساحل الشمالي



■ Alorouba Compound - North Cost

■ العروبة كمبوند - الساحل الشمالي



■ Golf Porto Marina

■ جولف بورتو مارينا



■ Amwaj - Sedi Abdelrahman

■ قرية أمواج - سيدي عبد الرحمن



■ Porto Matrouh

■ بورتو مطروح



■ Al Alamein New City

■ مدينة العلمين الجديدة



■ Luxor Governorate

■ محافظة الأقصر



■ New Assuit

■ أسبوط الجديدة



■ Suez Canal University - Ismailia

■ جامعة قناة السويس - الإسماعيلية



■ Fes City - Morocco

■ مدينة فاس - المغرب



■ Zanjibar Road - Yemen

■ طريق زنجبار - اليمن



■ King Abd El Aziz Seaport - Dammam - KSA ميناء الملك عبد العزيز - الدمام - السعودية ■



■ AL Riyad Metro Project - KSA

■ مشروع مترو الرياض - السعودية ■



■ National Research Center Certificates

■ شهادة المركز القومي للبحوث

Test	Standard	Tested Date	Result
Rate of Burning	ASTM-D635	2005	Pass
Tensile Strength	DIN EN ISO 527	2005	Pass
Elongation	DIN EN ISO 527	2005	Pass
Bending Strength	DIN 53390	2005	Pass
Impact Strength	DIN 53453	2005	Pass
Dielectrical Strength	ASTM D149-97a	2005	Pass

■ Faculty of Engineering Certificates- Cairo University جامعة القاهرة - شهادات كلية الهندسة

Test	Standard	Tested Date	Result
Rate of Burning	ASTM-E84	2003	Pass
Tensile Strength	ASTM 5083	2003	Pass
Elongation	ASTM 5083	2003	Pass
Bending Strength	ASTM 790	2003	Pass
Impact Strength	ASTM D256	2003	Pass
Dielectyric Strength	ASTM D257	2003	Pass
Fiber Glass Content	ASTM 2584	2003	Pass
Rigidity Test	ASTM 621	2003	Pass

■ National Institute for Standards Certificates شهادات المعهد القومي للقياس والمعايرة

Test	Standard	Tested Date	Result
Rate of Burning	ASTM D635	2010	Pass
Tensile Strength	DIN EN ISO 527-4&5	2010	Pass
Elongation	DIN EN ISO 527-4&5	2010	Pass
Bending Strength	BS EN ISO 14125	2010	Pass
Impact Strength	ASTM D6110	2010	Pass
General outdoor lighting poles specs	ASTM D4923	2011	Pass

تمت الاختبارات على عينات عشوائية من الأعمدة
 Testes have been done upon random samples

■ Design Standards

Standard	Issue Date
AASHTO 5 th EDITION	2015
BS EN 40-3-1	2013
BS EN 40-3-3	2013

■ Tests Standards

Mechanical Properties standards

Test	Standard	Issue Date
General outdoor lighting poles specs	ASTM-C136.20	2012
Tensile Strength	ISO 527 – 4&5	2014
Elongation	ISO 527 – 4&5	2014
Bending Strength	BS EN ISO 14125	1998
Impact Strength	ASTM D6110	2018

Electrical Properties standards

Test	Standard	Issue Date
Surface Resistivity	ASTM-D257	2014
Volume Resistivity	ASTM-D257	2014
Dielectric Strength	ASTM-D257	2014

Physical Properties standards

Test	Standard	Issue Date
Rate of Burning	ASTM-D635	2014

أعمدة الخرسانة	أعمدة الألمنيوم	أعمدة الحديد المجلفن	أعمدة الفايبرجلاس	وجه المقارنة
ثقيل جداً	متوسط	ثقيل	خفيف	وزن العمود
غير متاح	غير متاح	غير متاح	متاح	التثبيت بالدفن المباشر
ضعيف	ضعيف	ضعيف	عالي	ثبات اللون
صعب جداً	صعب	صعب	سهل	التركيب
موصل	موصل	موصل	غير موصل	التوصيل الكهربى
ضعيف	ضعيف	متوسط	عالي	مقاومة التآكل
قصير	متوسط	متوسط	طويل	العمر الافتراضى
منخفض جداً	منخفض	منخفض	عالي	الأمان
غير متاح	غير متاح	غير متاح	متاح	امكانية الطباغة على العمود
ضرورى	ضرورى	ضرورى	أختياري	توصيل الارضى
مطلوب	مطلوب	مطلوب	غير مطلوب	إعادة الطلاء
صعب جداً	صعب	صعب	سهل	التداول

Concrete Poles	Aluminum Poles	Galvanized Steel Poles	FRP Poles	Features
Too Heavy	Medium	Heavy	Light	Weight
N/A	N/A	N/A	Available	Direct Burial type
Poor	Poor	Poor	Excellent	Color Stability
Too Hard	Hard	Hard	Easy	Installation
Conductive	Conductive	Conductive	Non Conductive	Conductivity
low	Low	Medium	High	Corrosion Resistance
Short	Medium	Medium	Long	Lifespan
Very Low	Low	Low	High	Safety
N/A	N/A	N/A	Available	Printing Design
Obligatory	Obligatory	Obligatory	Optional	Earthing
Required	Required	Required	Not Required	Repainting
Too Hard	Hard	Hard	Easy	Handling



CERTIFICATE



This is to certify that

Egyptian Company for Plastic Industry (Elsewedy)
 PCF AG, No.363708 - 3rd Industrial Zone
 Elshohdy Region, 10th of Ramadan
 Elsharkia - Egypt

has implemented and maintains a **Quality Management System**.

Scope:
 Development and Production of PVC Compounds, Master Batch,
 Fiberglass Poles PP Filter and Special Compound (HFFR, Black Jacket and XLPE).

Through an audit, documented in a report, it was verified that the management system
 fulfills the requirements of the following standard:

ISO 9001 : 2015

Certificate registration no. 476511 QM15	
Valid from 2017-03-30	
Valid until 2020-03-29	
Date of certification 2017-03-30	

DQS GmbH

 Frank Gieseler
 Managing Director

Accredited Body: DQS GmbH, August-Straße 21, 40489 Frankfurt am Main, Germany
 Administrative Office: DQS Holding GmbH, Konrad-Adenauer-Platz 5-10, 51118 Bad Vilbel, Germany



CERTIFICATE



This is to certify that

Egyptian Company for Plastic Industry (Elsewedy)
 PCF AG, No.363708 - 3rd Industrial Zone, Elshohdy Region,
 10th of Ramadan, Elsharkia
 Egypt

has implemented and maintains an **Environmental Management System**.

Scope:
 Development and Production of PVC Compounds, Master Batch, Fiberglass Poles,
 PP Filter and Special Compound (HFFR, Black Jacket and XLPE).

Through an audit, documented in a report, it was verified that the management system
 fulfills the requirements of the following standard:

ISO 14001 : 2015

Certificate registration no. 476511 UM15	
Valid from 2018-03-31	
Valid until 2021-03-30	
Date of certification 2018-03-31	

DQS GmbH

 Stefan Heide
 Managing Director

Accredited Body: DQS GmbH, August-Straße 21, 40489 Frankfurt am Main, Germany
 Administrative Office: DQS Holding GmbH, Konrad-Adenauer-Platz 5-10, 51118 Bad Vilbel, Germany



CERTIFICATE



This is to certify that

Egyptian Company for Plastic Industry (Elsewedy)
 PCF AG, No.363708 - 3rd Industrial Zone
 Elshohdy Region, 10th of Ramadan
 Elsharkia - Egypt

has implemented and maintains an
Occupational Health and Safety Management System.

Scope:
 Development and Production of PVC Compounds, Master Batch,
 Fiberglass Poles PP Filter and Special Compound (HFFR, Black Jacket and XLPE).

Through an audit, documented in a report, it was verified that the management system
 fulfills the requirements of the following standard:

BS OHSAS 18001 : 2007

Certificate registration no. 476511 BSOH	
Valid from 2017-03-31	
Valid until 2020-03-30	
Date of certification 2017-03-30	

DQS GmbH

 Frank Gieseler
 Managing Director

Accredited Body: DQS GmbH, August-Straße 21, 40489 Frankfurt am Main, Germany
 Administrative Office: DQS Holding GmbH, Konrad-Adenauer-Platz 5-10, 51118 Bad Vilbel, Germany

Cairo – Alexandria Highway	طريق القاهرة – الأسكندرية الصحراوي
Cairo – El Shokhna Highway	طريق القاهرة – العين السخنة الصحراوي
El Salam Road – Sharm El Sheikh	طريق السلام – شرم الشيخ
Entrance of Qina – Red Sea Highway	مدخل طريق قنا – البحر الأحمر الصحراوي
International Costal Road	الطريق الدولي الساحلي
Marina North Coast Highway – Alexandria	طريق الساحل الشمالي الصحراوي – مارينا – الأسكندرية
Alexandria Corniche	كورنيش الأسكندرية
Ras El Bar Comiche – Damietta	كورنيش رأس البر – دمياط
Al Arish Corniche – North Sinai	كورنيش العريش – شمال سيناء
Al Mamora Corniche – Alexandria	كورنيش المعورة – الأسكندرية
El Montazah Corniche – Alexandria	كورنيش المنزهة – الأسكندرية
American University – Cairo	الجامعة الأمريكية – القاهرة
Pharos University – Alexandria	جامعة فاروس – الأسكندرية
Suez Canal University – Ismailia	جامعة قناة السويس – الإسماعيلية
Faculty of Medicine – alex. University – Alexandria	كلية الطب – جامعة الأسكندرية – الأسكندرية
Porto El Sokhna – Alein Al Skokhna – Suez	بورطو السخنة – العين السخنة – السويس
Golf Porto Marina – North Cost	جولف بورطو مارينا – الساحل الشمالي
Beverly Hills – 6 th of October	بيفرلي هيلز – السادس من أكتوبر
Smart Village – 6 th of October	القرية الذكية – السادس من أكتوبر
Al Gazirah Club – Giza	نادي الجزيرة – الجيزة
Petrosport Club – Cairo	نادي بتروسبورت – القاهرة
Kattamia Club – New Cairo	نادي القطامية – القاهرة الجديدة
Air Force Specialized – New Cairo	الستشفى الجوي التخصصي – القاهرة الجديدة
Al-Musheer Mosque – New Cairo	مسجد المشير – القاهرة الجديدة
90 th Street Bridge – New Cairo	كوبري شارع التسعين – القاهرة الجديدة
Koria & Makkady Gulf – Sahl Hashish – Red Sea	خليج كوريا ومكادي – سهل حشيش – البحر الأحمر
Green Plaza – Alexandria	جرين بلازا – الأسكندرية
Kaitbay Castel – Alexandria	قلعة قايتبائي – الأسكندرية
Doaa El Sama Village – North Cost	قرية دعاء السماء – الساحل الشمالي
Lopasha Resort – Hurghada	منتجع لوباشا – الغردقة
Al Ain Al Sokhna Seaport – Suez	ميناء العين السخنة – السويس
Alexandria Seaport – Alexandria	ميناء الأسكندرية – الأسكندرية
Safaga Seaport – Red Sea	ميناء سفاجا – البحر الأحمر
Cairo Airport – Cairo	مطار القاهرة – القاهرة
Marsa Alam Airport – Red Sea	مطار مرسى علم – البحر الأحمر
Ismailia Airport – Ismailia	مطار الإسماعيلية – الإسماعيلية
Amwaj Village	قرية امواج
New El Alamein City	مدينة العلمين الجديدة
King Abd El Aziz Seaport – dammam – KSA	ميناء الملك عبد العزيز – الدمام – المملكة العربية السعودية
Al – Uqair beach – Al Ahsaa – KSA	شاطئ العقير – الأحساء – المملكة العربية السعودية
Al Ahsaa Township – KSA	بلدية الأحساء – المملكة العربية السعودية
Fes City – Morocco	مدينة فاس – المغرب
Zanjibar Road - Yemen	طريق زنجبار – اليمن

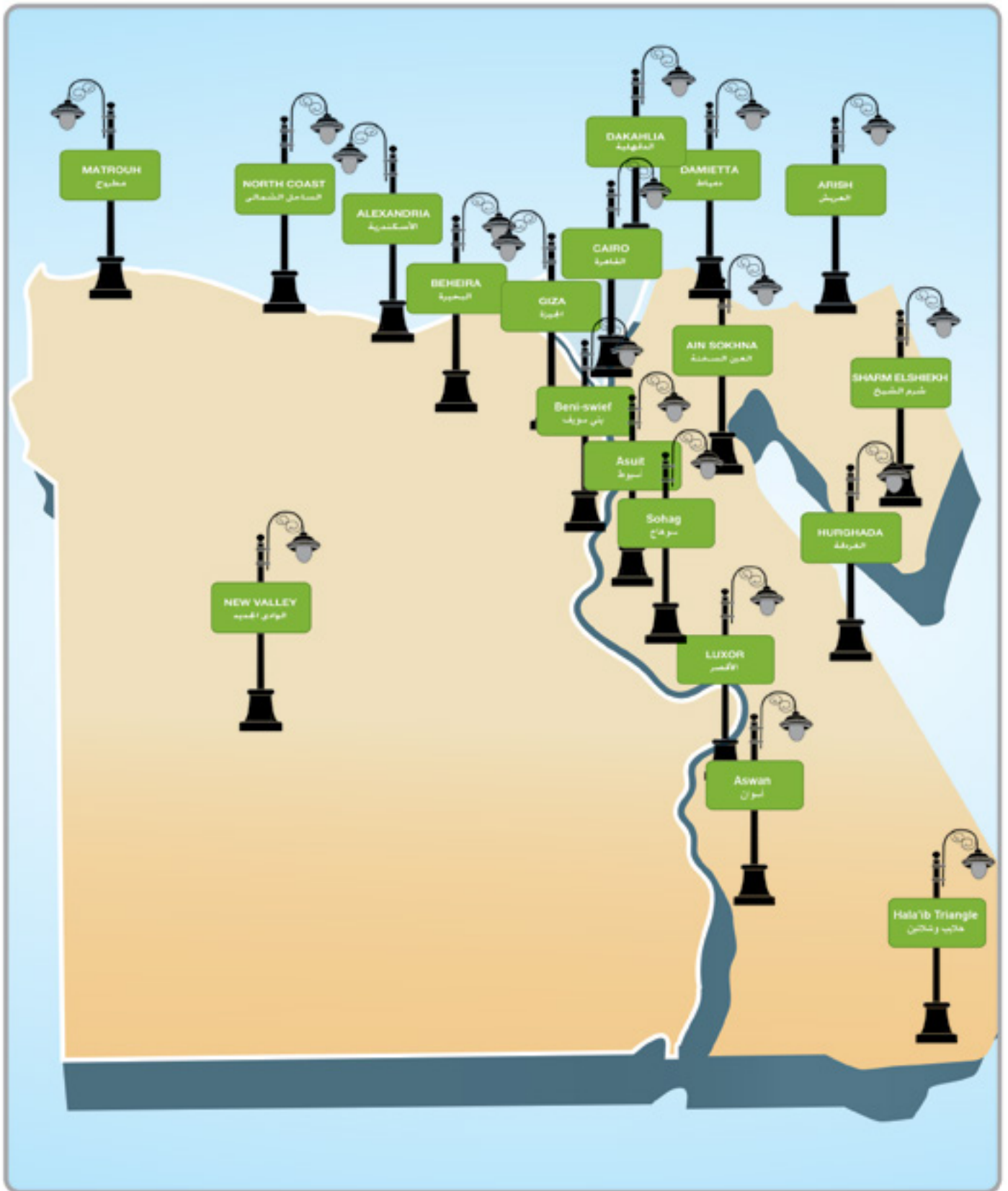

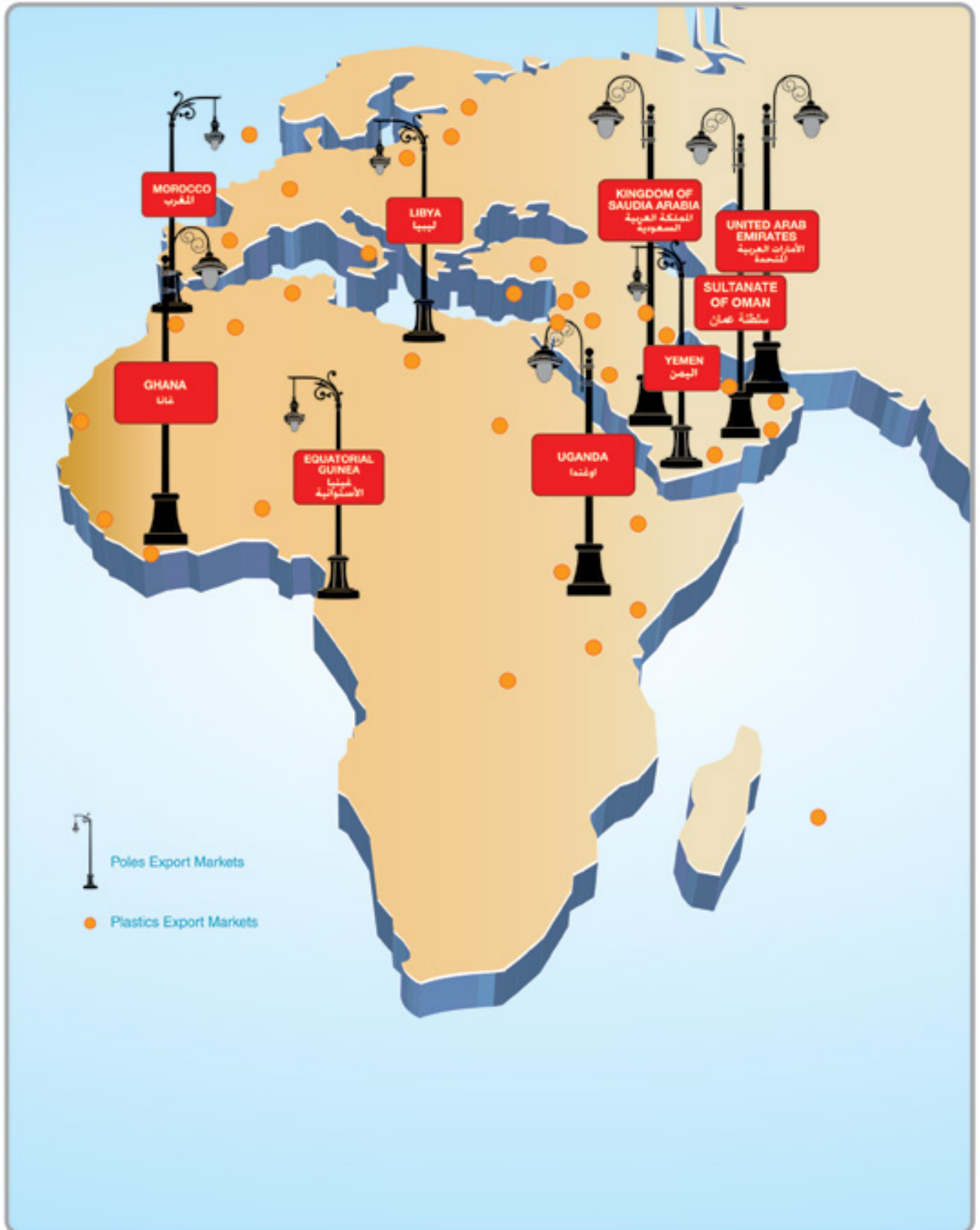



RAL 5005 Signal Blue



RAL 5015 Sky Blue



RAL 5007 Brilliant Blue



RAL 5002 Ultramarine Blue



RAL 5018 Turquoise Blue

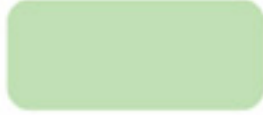

RAL 6019 Pastel Green



RAL 6029 Mint Green



RAL 6036 Pearl Opal Green



RAL 6033 Mint Turquoise



RAL 6027 Light Green



RAL 6010 Grass Green



RAL 5024 Pastel Blue



RAL 1016 Sulfur Yellow



RAL 1001 Beige



RAL 1018 Zinc Yellow



RAL 1021 Rape Yellow



RAL 7003 Moss Grey



RAL 8002 Signal Brown



RAL 2010 Signal Orange



RAL 1017 Saffron Yellow



RAL 1015 Light Ivory



RAL 1026 Melon Yellow



RAL 8023 Orange Brown



RAL 7006 Khaki Grey



RAL 2012 Salmon Orange

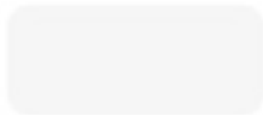

RAL 9016 Traffic White



RAL 9006 White Aluminium



RAL 9005 Jet Black



RAL 7015 Slate Grey



RAL 7035 Light Grey



RAL 7044 Silk Grey



RAL 8024 Beige Brown

يرجى مراجعة سلسلة RAL الأصلية عند اختيار اللون

Please check the original RAL Ref.

ELSEWEDY POLES

FIBERGLASS POLES
أعمدة فيبر جلاس

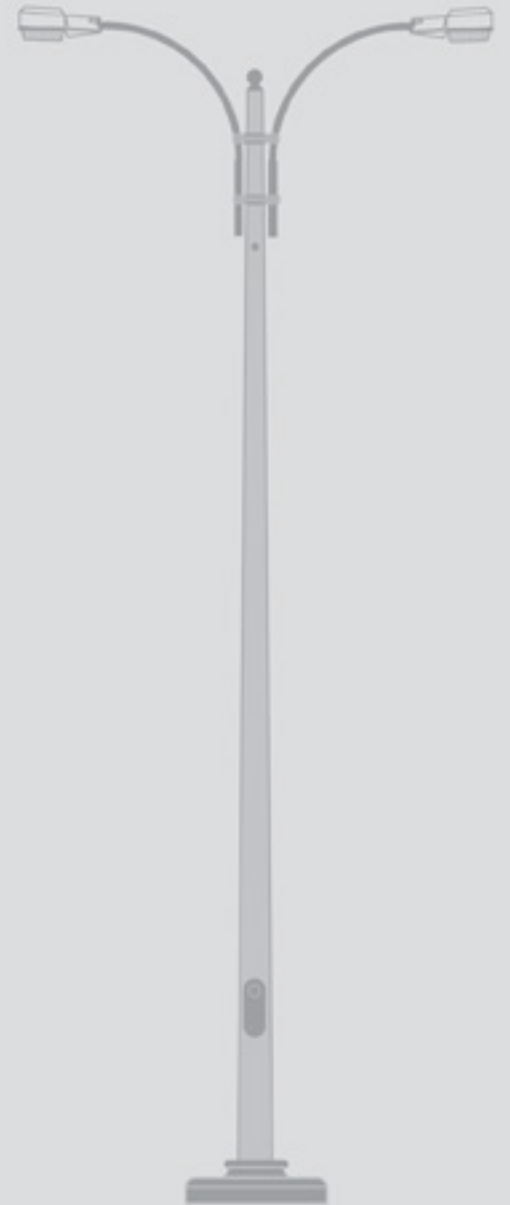

EGYPLAST

Egyptian Company for Plastic Industry (ELSEWEDY - EGYPLAST)

Management and Factories:

P.C. No. 36/37/38 Industrial Area A6, 10th of Ramadan City, Egypt.

Tel : +20554 411631 / 412131

Fax : +20554 411629

Customer Service : +201020707777 / +201207777270

Email : egyplast@elsewedy-plastic.com

Website : www.elsewedy-plastic.com

الشركة المصرية لصناعة البلاستيك (السويدي - إيجي بلاست)

الإدارة و المصانع:

قطعة رقم ٣٦/٣٧/٣٨ - المنطقة الصناعية أ٦ -

مدينة العاشر من رمضان - جمهورية مصر العربية

تليفون : +٢٠٥٥٤ ٤١١٦٣١ / +٢٠٥٥٤ ٤١١٦٣١

فاكس : +٢٠٥٥٤ ٤١١٦٢٩

خدمة العملاء : +٢٠١٢٠٧٧٧٧٢٧٠ / +٢٠١٢٠٧٧٧٧٢٧٠

بريد اليكتروني : egyplast@elsewedy-plastic.com

موقع اليكتروني : www.elsewedy-plastic.com

Subsidiary of

ELSEWEDY
ELECTRIC

